



# Guide for Electric Service and Meter Installations

**Revision: 1.02-2025**

**Effective Date: 6/2/2026**

Supersedes:

Description: Metering requirements for interconnection with the AEP Distribution System

Scan Here for Service Guide



# AEP Service Territory

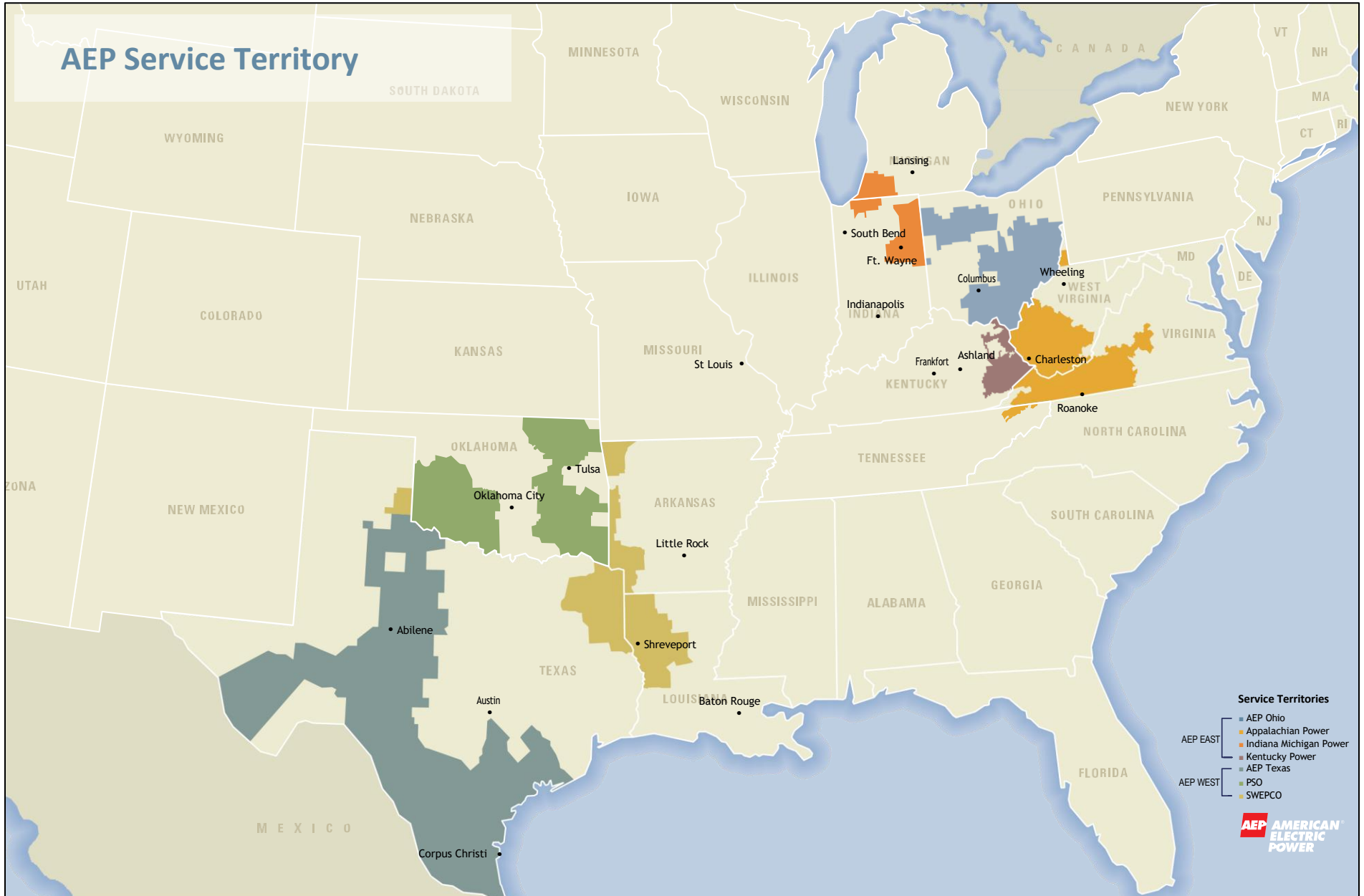

- Service Territories**
- AEP EAST
    - AEP Ohio
    - Appalachian Power
    - Indiana Michigan Power
    - Kentucky Power
    - AEP Texas
  - AEP WEST
    - PSO
    - SWEPCO



## Revision History

Version	Effective Date	Remarks
Rev. 1.02-2025	4/23/2026	Various adaptations of NEC and adjustments for practical construction methods.
Rev. 1.01-2025	7/8/2025	First publication under new format. <b>Changes of substance since last version are highlighted in yellow.</b>

## Preparation

Prepared By
DER Subject Matter Experts
Technical Writer

## Review and Retention

Review Frequency	Retention Period
Annual	Six Years

## Approval

Approved By	Title	Signature	Date
Meter Best Practice Team			4/22/2026

## Reviewers

Reviewed By	Title	Signature	Date
Meter Best Practice Team Voting Members			5/1/2025

	Guide for Electric Service and Meter Installations	Rev. 1.01	
	CAUTION: Printed copies of this document are uncontrolled and may be obsolete. Always check for the latest revision prior to use.		Page 3

**Contents**

Preface ..... 7

1.0 INTRODUCTION ..... 8

2.0 GLOSSARY ..... 9

    2.1 AEP-Specific Terms ..... 9

    2.2 Industry Terms ..... 11

3.0 ELECTRIC SERVICES AVAILABLE ..... 13

    3.1 General ..... 13

    3.2 Residential Service ..... 13

    3.3 Commercial and Industrial Service ..... 13

    3.4 Service at Voltages Above 240 Volts ..... 13

4.0 GENERAL REQUIREMENTS ..... 14

    4.1 Application for Electric Service ..... 14

    4.2 Extension of Company’s Facilities ..... 14

    4.3 Installation and Responsibility ..... 14

    4.4 Requirements for Electrical Inspection ..... 15

    4.5 Customer Alterations and Additions ..... 15

    4.6 Temporary Service ..... 15

    4.7 Structures Near Overhead Lines ..... 15

    4.8 Attachments to Company-Owned Facilities ..... 15

    4.9 Access to Customer’s Premises ..... 15

    4.10 Qualification as a Permanent Single-Family Dwelling ..... 16

    4.11 Surge Protection Requirement ..... 17

5.0 OVERHEAD SERVICE REQUIREMENTS ..... 19

    5.1 Service from Overhead Lines ..... 19

    5.2 Mobile Home Overhead Service ..... 19

    5.3 Surge Protection Requirement ..... 20

6.0 UNDERGROUND SERVICE REQUIREMENTS ..... 20

	Guide for Electric Service and Meter Installations	Rev. 1.01	
	CAUTION: Printed copies of this document are uncontrolled and may be obsolete. Always check for the latest revision prior to use.		Page 4

6.1	Underground Service .....	20
6.2	Mobile Home Underground Service .....	20
6.3	Surge Protection Requirement.....	21
7.0	SERVICE ENTRANCE .....	22
7.1	Service Entrance Conductors .....	22
7.2	Commercial or Industrial Service Entrances.....	22
7.3	Transformer Vaults.....	23
7.4	Grounding .....	23
8.0	METERING EQUIPMENT.....	24
8.1	Meter Location .....	24
8.2	Meter Sockets .....	25
8.3	Meter Identification on Multi-Occupancy Buildings.....	26
8.4	Relocation of Service and Meter Equipment.....	27
8.5	No Connections Allowed Ahead of Metering Devices .....	27
8.6	Seals .....	27
8.7	Energy Management.....	27
8.8	Underground Service with Current Transformer Metering.....	28
8.9	Separately Metered Electric Vehicle Service .....	28
9.0	CUSTOMER'S SERVICE EQUIPMENT.....	28
9.1	General.....	28
9.2	Service Equipment Rating .....	28
9.3	Customer-Owned Current Transformer (CT) Enclosures Specifications.....	29
9.4	Customer-Owned Enclosures .....	30
9.5	Surge Protection Requirement.....	30
10.0	CUSTOMER'S UTILIZATION EQUIPMENT.....	31
10.1	General.....	31
10.2	Voltage Fluctuation and Flicker Limits.....	31
10.3	Current/Voltage Harmonic Distortion Limits.....	31

10.4 Protection For Voltage-Sensitive Equipment ..... 32

10.5 Motors..... 32

11.0 EMERGENCY DISCONNECTS..... 33

    Requirements ..... 33

12.0 DISTRIBUTED ENERGY RESOURCES (DER) ..... 33

    12.1 Basic Residential DER system with Production meter ..... 33

    12.2 Application Submission ..... 34

    12.3 Point of Connection (PoC) Meter Socket..... 34

    12.4 DER Disconnect ..... 35

    12.5 General Instructions ..... 35

    12.6 Completion and Inspection ..... 35

    12.7 Conditionally Acceptable Winding Configurations ..... 35

    12.8 Prohibited Cases..... 36

13.0 EV (Electric Vehicles) ..... 36

14.0 ESS (Energy Storage Systems)..... 37

    14.1 Energy Storage System..... 37

    14.2 Notification and Marking..... 37

15.0 Emergency Stand-By Generators..... 38

16.0 Portable Generators ..... 38

17.0 Figures ..... 39

Appendix ..... 80

	Guide for Electric Service and Meter Installations	Rev. 1.01	
	CAUTION: Printed copies of this document are uncontrolled and may be obsolete. Always check for the latest revision prior to use.		Page 6

# Preface

---

Published 2025.

This booklet is not intended to conflict with the National Electrical Safety Code, the National Electrical Code, or such state and local laws or ordinances as may be in force in the Company Service Area.

The following electric service guidelines are the Company requirements at the date of publication and are subject to change. Article 90 of the National Electrical Code establishes the Utility as the Authority Having Jurisdiction over installations consisting of service drops or service laterals and associated metering equipment (up to and including service disconnecting means). AEP is not to supersede State or Federal rules or regulations. American Electric Power Company personnel should be contacted for the latest requirements in effect.

Link to AEP Requirements for Service:

<https://www.aepnationalaccounts.com/builders/Requirements.aspx>

## Contact Information

E-mail: [Customer\\_Service@aep.com](mailto:Customer_Service@aep.com)

Phone Numbers:

<b>AEP Ohio Customer Service</b>	Phone: 800-672-2231
<b>AEP Texas Customer Service</b>	Phone: 877-373-4858
<b>Appalachian Power Customer Service</b>	Phone: 800-982-4237
<b>Arkansas Customer Service</b>	Phone: 888-216-3523
<b>Indiana Michigan Power Customer Service</b>	Phone: 800-311-4634
<b>Kentucky Customer Service</b>	Phone: 800-572-1113
<b>Public Service of Oklahoma Customer Service</b>	Phone: 888-216-3523
<b>Southwestern Power Customer Service</b>	Phone: 888-216-3523

	Guide for Electric Service and Meter Installations	Rev. 1.01	Page 7
	CAUTION: Printed copies of this document are uncontrolled and may be obsolete. Always check for the latest revision prior to use.		

## 1.0 INTRODUCTION

---

This informational booklet is issued by American Electric Power Company for the guidance of Customers, engineers, architects, contractors, and other interested parties planning electrical installations for residential buildings and small commercial establishments. The information and recommendations set forth herein are, in general, sufficient to answer questions concerning a majority of the installations within its scope. When questions arise which are not covered by this document, the Company will provide information to best address these questions or any other matter pertaining to its Service, defined in Chapter 2.

When planning electrical installations for larger commercial or industrial establishments, it will be necessary for the engineer, architect, or electrical contractor to contact the Company for detailed information on service requirements.

All Customer-owned equipment shall be installed in accordance with the requirements of the latest revision of the National Electrical Code (NEC), or of any federal, state, county or municipal laws or statutes that may be in effect for governing electrical installations in the area where the installation is made. The Customer, engineer, architect, and electrical contractor should ascertain that such requirements are met.

The National Electrical Safety Code (NESC), the NEC and various federal, state, county and municipal ordinances have been created and adopted to minimize and mitigate hazards to life and property created by any electrical installation. These codes and ordinances do not guarantee that the electrical installation meets adequately the customer's present or future electric service needs.

The requirements set forth herein are not necessarily complete facility or safety specifications; they instead cover matters of mutual concern to the Customer and the Company, which facilitate the supplying of electric service. The requirements are subject to revision from time to time without notification so that they keep pace with developments and progress in the electric industry. Compliance with these requirements does not absolve the Customer from the obligation to install and maintain wiring and equipment in a safe condition: the Company does not accept any responsibility for the quality or condition of the Customer's wiring or equipment. It is expected that the Customer's electrical installation be capable through its circuits and circuit capacity not only of serving the electrical devices extant in 2025 in a safe, efficient, and convenient manner, but also capable of handling future load growth.

	Guide for Electric Service and Meter Installations	Rev. 1.01	
	CAUTION: Printed copies of this document are uncontrolled and may be obsolete. Always check for the latest revision prior to use.		Page 8

## 2.0 GLOSSARY

### 2.1 AEP-Specific Terms

Term	Definition
<b>AEP East</b>	The following operating companies: AEP Ohio, Appalachian Power (APCo), Indiana Michigan Power (I&M), and Kentucky Power (KYPCo).
<b>AEP West</b>	The following operating companies: AEP Texas, Public Service of Oklahoma (PSO), and Southwestern Electric Power Company (SWEPCo).
<b>Clearances</b>	The clear distance between two objects measured surface to surface. The clearance above ground, driveways, roads, etc. specified in this guide are the minimum required by the NESC for electrical conductor sag conditions. As such, during actual installations, higher clearances may be required to allow for the increased sag of cables/conductors under all conditions.
<b>Company</b>	American Electric Power Company and its affiliates.
<b>Customer</b>	A present or prospective user of the Company's electric service.
<b>Distributed Energy Resource (DER)</b>	A source of electric power, along with any interconnection system or supplemental device as required under IEEE Std 1547™-2018, which operates in parallel with the distribution system and is capable of exporting active power to an EPS.
<b>Grounded system (neutral)</b>	An electrical system that is grounded by intentionally connecting the system neutral point to ground.
<b>Grounding system</b>	An electrical system that provides another electrical system, such as a Grounded system, connection to Ground.
<b>Qualified Person</b>	One who has skills and knowledge related to the construction and operation of the electrical equipment and installations and has received safety training to recognize and avoid the hazards involved.
<b>Readily Accessible</b>	Capable of being reached quickly for operation, renewal, or inspections, without the necessity of climbing over or removing

	Guide for Electric Service and Meter Installations	Rev. 1.01	
	CAUTION: Printed copies of this document are uncontrolled and may be obsolete. Always check for the latest revision prior to use.		Page 9

Term	Definition
	obstacles or resorting to portable ladders, stepstools, etc., or the requirement of making special arrangements or appointments.
<b>Service</b>	The conductors and equipment for delivering electric energy from the serving utility to the wiring system of the premises served. Service has also come to be known as the supply of the Company's product, electricity, to the Customer.
<b>Service Drop</b>	The overhead service conductors from the last pole or other aerial support to and including the splices, if any, connecting to the service-entrance conductors at the building or other structure.
<b>Tension</b>	The tension limits, if any, specified in this guide are the maximum limited by the NESC under applicable loading conditions. Hence, during installation, stringing sags and tensions provided by the Company standards will be used.
<b>Point of Delivery</b>	<p><b>Metered Loads with Self-Contained Meters</b></p> <p>The conductor termination lugs on the load side of the meter base.</p> <p><i>Note: Multiple conductors electrically connected to the same point with reference to the meter will be considered a single Point of Delivery.</i></p> <p><b>Metered Loads with Transformer Rated Meters</b></p> <p>Customer-owned conductor terminations on the load side of the metering current transformers in or on customer owned equipment.</p> <p><i>Note: Multiple conductors electrically connected to the same point with reference to the meter will be considered one Point of Delivery.</i></p> <p><b>Non-Metered Loads</b></p> <p>Customer-owned conductor terminations nearest to the AEP owned conductor terminations. <i>Note: Multiple conductors electrically connected to the same point with reference to the AEP owned conductor terminations will be considered a single Point of Delivery.</i></p>
<b>Disconnecting Means</b>	<p><b>Secondary Voltages (below 600 volts):</b></p> <p>Circuit breaker</p>

Term	Definition
	<p>Fuses in series with a double throw visible disconnect switch</p> <p><b>Primary Voltages (600 volts and above):</b></p> <p>Circuit breaker</p> <p>Fused disconnects</p> <p>Gang operated disconnect switch</p> <p>Individually operated disconnect switches</p>

## 2.2 Industry Terms

Definitions for the following terms can be found in the National Electrical Code and are shown below, taken from NEC 2023:

Term	Definition
<b>Feeder</b>	All circuit conductors between the service equipment, the source of a separately derived system, or other power supply source and the final branch-circuit overcurrent device.
<b>Ground</b>	The earth.
<b>Grounding Conductor</b>	<p>A conductive path(s) that is part of an effective ground-fault current path and connects normally non-current-carrying metal parts of equipment together and to the system grounded conductor or to the grounding electrode conductor, or both.</p> <p><i>Note: It is recognized that the equipment grounding conductor also performs bonding. See NEC (2023) 250.118 for a list of acceptable equipment grounding conductors.</i></p>
<b>Grounding Electrode Conductor</b>	A conductor used to connect the system grounded conductor or the equipment to a grounding electrode or to a point on the grounding electrode system.
<b>Service Conductor</b>	A conductor from the service point to the service disconnecting means.
<b>Service Entrance Conductor</b>	A service conductor between the terminals of the service equipment to the service drop, overhead service conductors, service lateral, or underground service conductors.

	Guide for Electric Service and Meter Installations	Rev. 1.01	
	CAUTION: Printed copies of this document are uncontrolled and may be obsolete. Always check for the latest revision prior to use.		Page 11

	<i>Note: Where service equipment is located outside the building walls, there could be no service-entrance conductors or they might be entirely outside the building.</i>
<b>Overhead Service Conductors</b>	The overhead conductors between the service point and the first point of connection to the service-entrance conductors at the building or other structure.
<b>Underground Service Conductors</b>	The underground conductors between the service point and the first point of connection to the service-entrance conductors in a terminal box, meter, or other enclosure, inside or outside the building wall.  <i>Note: Where there is no terminal box, meter, or other enclosure, the point of connection is considered to be the point of entrance of the service conductors into the building.</i>
<b>Service Equipment</b>	The necessary equipment, consisting of a circuit breaker(s) or switch(es) and fuse(s) and their accessories, connected to the serving utility and intended to constitute the main control and disconnect of the serving utility.
<b>Service Lateral</b>	The underground conductors between the utility electric supply system and the service point.
<b>Service Point</b>	The point of connection between the facilities of the serving utility and the premises wiring.  <i>Note: The service point can be described as the point of demarcation between where the serving utility ends and the premises wiring begins. The serving utility generally specifies the location of the service point based on the conditions of service.</i>

## 3.0 ELECTRIC SERVICES AVAILABLE

---

### 3.1 General

One system of electrical distribution is available, namely 60 Hertz alternating current. The voltage and the number of phases to be supplied depends upon the character of the load as well as its size and location; therefore, it is necessary for the Customer to consult the Company regarding the type of service which will be furnished *before* proceeding with the purchase of equipment or the installation of wiring.

All services requested by the Customer shall be metered for energy consumption, except for dusk-to-dawn lights and other special services covered under a tariff containing provisions for optional un-metered service. Commercial Customers, depending on load, may require demand and reactive metering. Time-of-use metering may be available depending on the Customer load and tariff.

### 3.2 Residential Service

Depending on availability or requirement, Residential Service will be supplied in either of two configurations: single-phase three-wire, nominally 120/240 volts; or network three-wire, nominally 120/208 volts.

### 3.3 Commercial and Industrial Service

The secondary distribution available to serve commercial and industrial loads may be a three-wire, single-phase system, three-wire, three-phase system or four-wire, three-phase system. The Company should always be consulted in regard to the exact characteristics of the service that will be available.

### 3.4 Service at Voltages Above 240 Volts

Service may be available for applications at voltages higher than 240 volts. Refer to the "Terms and Conditions" of your contract with the appropriate company for service voltages available.

	Guide for Electric Service and Meter Installations	Rev. 1.01	
	CAUTION: Printed copies of this document are uncontrolled and may be obsolete. Always check for the latest revision prior to use.		Page 13

## 4.0 GENERAL REQUIREMENTS

---

### 4.1 Application for Electric Service

Application for electric service for either a new installation or a revision of service for an existing installation must be made to and accepted by the Company before service will be supplied. Application can be made by contacting the Company and should be made as far in advance as possible of the date service is required. The Customer must consult the Company for information concerning the point of attachment of the Company's service facilities to the Customer's building, the location of the meter, characteristics of service, and other pertinent matters before proceeding with the installation of the service.

Application for Texas Choice can be made by contacting a Retail Electric Provider and should be made as far in advance as possible of the date service is required.

### 4.2 Extension of Company's Facilities

The Company will extend its facilities to provide service in accordance with the provisions of its tariffs on file with the Public Service Commission. When the Customer requests the Company to deliver energy in a manner or location other than that designated by the Company, the Customer will be required to pay the additional costs. The Company will be pleased to discuss its terms and conditions for the extension of facilities upon request.

### 4.3 Installation and Responsibility

To best protect the Customer, all electrical wiring and apparatuses must be installed and maintained in a safe manner with the work performed by a licensed electrician or other qualified party. The Customer, in accepting service from the Company, assumes full responsibility for the safety of the wiring and apparatus which the Customer installs.

The Customer shall not operate any apparatus which creates a condition that interferes with the Company's operation and prevents the Company from supplying satisfactory service to the Customer or to other Customers. Such a condition includes, but is not limited to, operating equipment that interferes with the satisfactory operation of other Customers' radio, television, and communication equipment.

The Company reserves the right to place restrictions on the type and manner of use of any of the Customer's electrical equipment that is connected to the Company's lines, especially prohibiting any large loads of highly fluctuating voltage and/or frequency or having low power factor characteristics.

Antioxidant compounds **SHALL NOT BE USED ON METER SOCKET BLADES OR METER BASE JAWS.**

	Guide for Electric Service and Meter Installations	Rev. 1.01	
	CAUTION: Printed copies of this document are uncontrolled and may be obsolete. Always check for the latest revision prior to use.		Page 14

Antioxidant compounds can be used on *aluminum conductors* and meter base terminal per the AHJ of your area.

#### 4.4 Requirements for Electrical Inspection

The Customer is responsible for obtaining inspections on work done to their electrical system as required by the local inspection authority.

#### 4.5 Customer Alterations and Additions

The Company's facilities used to provide service have definite capacity limitations and can be damaged by overloads. Therefore, the Customer must notify the Company prior to making alteration to the service entrance equipment so that facilities of proper capacity may be provided.

**The Customer shall be responsible for all expenses and/or damages to Customer's facilities resulting from failure to give proper notice. The Customer may also be subject to charges by the Company for work required to meet the Customers' alteration. The Customer should contact the Company for information concerning charges for such work.**

#### 4.6 Temporary Service

The Company has specific requirements for temporary service and should be consulted for each case. Where the temporary service installation is to be used in conjunction with construction work, the Company's structural requirements are shown in Figures M.S.\_F001 and M.S.\_F003.

#### 4.7 Structures Near Overhead Lines

Structures, including signs, flagpoles, light standards, antennas, or aerials shall not be installed under, over, or in such close proximity to lines carrying electric current that they could be raised into or fall onto such lines or that they cannot be safely maintained. Antennas or aerials shall not be attached to a Company pole, or any pole used in supplying electric service to the Customer. Consult the Company for clearance requirements.

#### 4.8 Attachments to Company-Owned Facilities

Under no conditions will the Customer's facilities be installed on the Company's poles or other property unless special arrangements have been made with the Company.

#### 4.9 Access to Customer's Premises

The Company's authorized agents and employees shall have access to the Customer's premises, only to the extent needed by the Company for access to its property and at all reasonable hours, for the purposes necessary in connection with supplying and maintaining service. Upon termination of

	Guide for Electric Service and Meter Installations	Rev. 1.01	
	CAUTION: Printed copies of this document are uncontrolled and may be obsolete. Always check for the latest revision prior to use.		Page 15

service, the Company shall be permitted to remove any or all such property. Authorized Company employees visiting the premises of the Customer for any purposes are furnished with an identification card. The Customer should refuse admission to people who do not have proper identification.

## 4.10 Qualification as a Permanent Single-Family Dwelling

### 4.10.1 Virginia, West Virginia, Oklahoma, Kentucky Customers

For the purpose of qualifying as a permanent single-family dwelling, the dwelling to be served must become a permanent part of the property upon which it is located by meeting the following requirements:

- The dwelling must be directly connected to a pressurized potable water supply from either a well, public water system or other reasonable source meeting Health Department standards.
- The dwelling must be connected to a public or private sewage disposal system septic tank/drain field or alternate sewage disposal system meeting Health Department standards.
- The dwelling must contain separately identifiable kitchen, bedroom and living room areas. (This requirement does not apply in Virginia)
- If the dwelling is a mobile home, the wheels must be removed, and the dwelling must be installed on a permanent foundation that meets the requirements of local building codes. A permanent foundation can be either a perimeter or a pier-type with concrete blocks or poured concrete.

Service extensions to any dwelling not meeting the permanence requirements set forth above, such as, without limitation, a hunting or fishing camp, camper, travel trailer, recreational vehicle or any other structure mounted on wheels which does not require a special permit to move along the highway or be towed by a motorized vehicle, shall be provided under the extension provisions for non-residential service.

### 4.10.2 Ohio Customers

“Permanent” regarding structures means:

- a) a structure that has a permanently installed pressurized domestic water system and septic/sewer system which complies with local codes/regulations and is approved for use by the respective sanitation jurisdictional authority, or

	Guide for Electric Service and Meter Installations	Rev. 1.01	
	CAUTION: Printed copies of this document are uncontrolled and may be obsolete. Always check for the latest revision prior to use.		Page 16

- b) a structure that is approved for installation on a foundational support that is either a mortared masonry pier/column configuration, a poured concrete slab, or a poured concrete footer and mortared masonry walls on the perimeter of the structure.

**A. Permanent Residential**

*From the AEP Ohio Terms and Conditions of Service:*

Available to customers desiring secondary service for all residential purposes through one meter to a single or double occupancy dwelling unit including farm dwellings and who request and receive electric generation service from either a SSO or a qualified CRES Provider. Customers desiring primary voltage will be served under a general service schedule. A dwelling unit consists of a kitchen, bathroom, and heating facilities connected on a permanent basis. Service to appurtenant buildings may be taken on the same meter. This rate is not available for common areas of separately metered apartments and condominium complexes, nor to a separate meter which serves other non- dwelling applications. In the event a detached garage or other facility on a residential customer’s property is separately served and metered; such facility shall be metered and billed based on whether or not the structures are used for commercial business. Commercial use will be billed according to the appropriate general service schedule.

To qualify as a residence, it must be considered a dwelling. Because a dwelling must consist of a kitchen, bathroom, and heating facilities connected on a permanent basis, then it must meet “a” in the permanent definition above.

**B. Residential Outbuilding**

In the event a detached garage or other facility on a residential customer’s property is separately served and metered; such facility shall be metered and billed based on whether the structures are used for commercial business. Commercial use will be billed according to the appropriate general service schedule.

**4.11 Surge Protection Requirement**

AEP requires that surge protection be employed as per NEC 2020 article 230.67. Surge Protection in all new service and service updates shall be as prescribed below.

**Surge-Protective Device.** All service supplying dwelling units must be provided with a surge-protective device (SPD).

**Location.** The surge-protective device for dwelling units must be an integral part of the service disconnect or be immediately adjacent to the service disconnect.

*Exception:* The surge-protective device is permitted to be at the downstream panelboard. An example application of this exception is where there is an exterior meter main that feeds an interior

	Guide for Electric Service and Meter Installations	Rev. 1.01	
	CAUTION: Printed copies of this document are uncontrolled and may be obsolete. Always check for the latest revision prior to use.		Page 17

panel. The SPD could be installed at the interior panel per this exception. See Parts 1 and 2 of NEC article 242 for installation requirements that apply to SPDs.

**Type.** The surge-protective device must be a Type 1 or Type 2 SPD.

**Replacement.** Where service equipment is replaced, surge protection must be installed.

Lead lengths of conductors to the SPD should be kept *as short as possible* to reduce let-through voltages.

	Guide for Electric Service and Meter Installations	Rev. 1.01	
	CAUTION: Printed copies of this document are uncontrolled and may be obsolete. Always check for the latest revision prior to use.		Page 18

## 5.0 OVERHEAD SERVICE REQUIREMENTS

### 5.1 Service from Overhead Lines

Figures M.S.\_F005 and M.S.\_F006 show the Company's specifications for overhead service attachments on buildings. The Company will furnish and install the service drop conductors extending from the Company's service pole to a point of attachment on the structure. The Company reserves the right in all cases to specify this point of attachment. In general, it will be at a point on the structure nearest the distribution pole from which the structure is to be served.

Service drop conductors shall be attached to the structure or building at a height required to maintain minimum clearance of the service drop wires over and above sidewalks, alleys, driveways (including residential), and public roads. When it is necessary, the Customer or the Customer's contractor shall furnish and install a properly secured and anchored mast to obtain the required clearances, as shown in M.S.\_F005. All clearances shall conform to the requirements of the latest issue of the NESC or other local regulations, whichever is applicable.

Where the point of attachment is located on a building constructed of wood, tile, stucco, concrete, asbestos shingles, plastered metal lath, brick veneer, or sheet iron, the customer or the Customer's contractor shall install the necessary facilities for mounting and securing the service drop attachments, which should withstand the maximum tension of the service drop cable. For proper tension, which depends on the size and number of service conductors, the Company should be consulted.

### 5.2 Mobile Home Overhead Service

Figure M.S.\_F004 shows the details of the Company's requirements for an overhead service to a mobile home. When this type of service is requested, the Company will approve the service equipment installation to ensure that it meets the Company's construction requirement.

A mobile home service requires a four-wire conductor cable that has a grounded circuit conductor (neutral), as well as a grounding conductor (ground) installed between the mobile home and its adjacent service equipment in accordance with the NEC. The grounded circuit conductor (neutral) shall be insulated from the grounding conductor and from equipment enclosures and other grounded parts. As per the requirements of the latest revision of the NEC, neither the frame of the mobile home nor the frame of any distribution panel or an appliance may be connected to the grounded neutral conductor in the mobile home. The grounding conductor and the grounded neutral conductor are bonded together only at the service disconnecting means.

Antioxidant compounds **SHALL NOT BE USED ON METER SOCKET BLADES OR METER BASE JAWS.**

Antioxidant compounds can be used on *aluminum conductors* and meter base terminal per the AHJ of your area.

	Guide for Electric Service and Meter Installations	Rev. 1.01	Page 19
	CAUTION: Printed copies of this document are uncontrolled and may be obsolete. Always check for the latest revision prior to use.		

### 5.3 Surge Protection Requirement

See Section 4.11 – Surge Protection Requirement

## 6.0 UNDERGROUND SERVICE REQUIREMENTS

---

### 6.1 Underground Service

Where the installation of an underground service is contemplated, the Customer or the Customer’s contractor shall consult the Company. Figure M.S.\_F008 shows the Company's specifications for underground service. Notice is hereby given that any time underground service is requested of the Company, it is the responsibility of the property owner and/or the owner’s agents to have any underground facilities marked that are not a part of the one number call system. These would include service water lines, drainage tiles, private lighting systems, sprinkler systems, and geothermal systems. The Company will not be responsible for any damages to unmarked facilities.

### 6.2 Mobile Home Underground Service

Figures M.S.\_F009 and M.S.\_F009A show the Company's requirements for underground service to a mobile home using a pressure-treated wood post. When service is requested, the Company will approve the service equipment installation, including wood post location, to ensure that it meets the Company's construction requirements.

On this type of installation, the wood post and any other wood accessories used by the customer, shall be pressure treated lumber. Plywood, particleboard, or untreated posts are not acceptable. Screws and nails used to fasten the metering equipment to the wood structure shall be the galvanized, stainless, or aluminum type.

A mobile home service requires a four-wire conductor cable containing a grounded circuit conductor (neutral), as well as a grounding conductor (ground) installed between the mobile home and its adjacent service equipment in accordance with the NEC. Neither the frame of the mobile home nor the frame of any distribution panel or appliance may be connected to the grounded neutral conductor in the mobile home. The grounding conductor and the grounded neutral conductor are bonded together only on the supply side of the service disconnecting means.

Antioxidant compounds **SHALL NOT BE USED ON METER SOCKET BLADES OR METER BASE JAWS.**

Antioxidant compounds can be used on *aluminum conductors* and meter base terminal per the AHJ of your area.

	Guide for Electric Service and Meter Installations	Rev. 1.01	
	CAUTION: Printed copies of this document are uncontrolled and may be obsolete. Always check for the latest revision prior to use.		Page 20

## 6.3 Surge Protection Requirement

See Section 4.11 – Surge Protection Requirement

	Guide for Electric Service and Meter Installations	Rev. 1.01	
	CAUTION: Printed copies of this document are uncontrolled and may be obsolete. Always check for the latest revision prior to use.		Page 21

## 7.0 SERVICE ENTRANCE

---

### 7.1 Service Entrance Conductors

The service entrance cable or raceway, which extends from the point of attachment on the structure to the Company-owned metering equipment, shall be run exposed for its entire length except in those cases where it is necessary to pass through over-hanging eaves or projections from the main wall of the building. Where pass-through is necessary, the service entrance cable shall be protected from physical damage in accordance with the NEC. Where conduit is used for protecting service entrance conductors, there shall be no joints in the length of conduit that is covered by the building construction. For the purpose of obtaining necessary clearance to the ground for service drop conductors, and in cases deemed acceptable to the Company, a rigid metallic conduit will be required and may extend through the roof not more than 36 inches unless guyed. Figure M.S.\_F006 shows one example of this type of construction. The service entrance conductors and conduit will be furnished and installed by the customer or their contractor. Appropriate clearances of overhead electric supply lines shall be maintained in accordance with the NESC at all times.

### 7.2 Commercial or Industrial Service Entrances

The service entrance conductor needs of commercial and/or industrial customers are usually more complex than those for residential customers. To assure that such services meet the electrical load requirements, the Company shall be consulted in every case before plans are made or equipment is purchased. Service entrance conductors that are furnished and installed by the Customer shall be in accordance with the requirements of the NEC. In cases where the Company supplies the service, the requirements of the NESC shall govern.

For those commercial metering installations (below 600 volts) that require a current transformer cabinet/enclosure, the customer shall furnish and install the cabinet as specified in M.S.\_F010 or M.S.\_F011. The enclosure shall have provision for Company lock and seal, which is solely for Company access. All enclosures shall be of substantial strength painted galvanized steel NEMA 3R. Local inspecting authorities may require the enclosure to be UL- or ETL-listed.

Where for commercial metering installations the Company installs bushing-type current transformers in Company pad-mount transformers, the Customer will install, per Figure M.S.\_F013, the transformer-rated meter socket on the side of the building if the Company's pad-mount transformer is within 25 feet. If not, the socket shall be installed as per Figure M.S.\_F014. Distances greater than 25 feet must be approved by Meter Services.

Bolted connections shall be made in accordance with Figure M.S.\_F017.

All services from AEP three-phase pad mount transformers are 4 wire - WYE connected. The neutral conductors are required to be grounded both at the Company transformer and at the Customer's

	Guide for Electric Service and Meter Installations	Rev. 1.01	Page 22
	CAUTION: Printed copies of this document are uncontrolled and may be obsolete. Always check for the latest revision prior to use.		

switchgear. The neutral connection is required to protect against line-to-ground faults. AEP will not connect a service without the proper neutral connection.

### 7.3 Transformer Vaults

Where the service requires a transformer vault the Customer shall, in every case, consult the Company regarding the location and construction before plans are made. The customer will normally provide the transformer vault(s) to the Company’s specifications. If the customer chooses not to provide the vault(s) on their property, then the Company, at its option, will provide these facilities at a suitable location and may require reimbursement as an aid to construction. Such vaults shall comply with the requirements of Article 450 of the NEC and such local and Company requirements as may be in force at the time the installation is made. Any pipe or duct system foreign to the electrical installation shall not enter or pass through a transformer vault. Piping or other facilities provided for vault fire protection or for transformer cooling shall not be considered foreign to the electrical installation.

Access to such vaults shall be limited only to authorized Company personnel. Transformer vaults shall contain only the Company's transformers and their auxiliary and spare equipment. Materials shall not be stored in transformer vaults. Customer's secondary circuit breakers, fuses, and switches shall not be installed in the vault.

### 7.4 Grounding

The grounded neutral conductor of the service entrance conductors shall be grounded in accordance with the NEC.

All conduits, metallic tubing and service entrance equipment shall be grounded in accordance with the latest revision of the NEC. The NEC or other local governing code shall be consulted at the time regarding dimensions, specification of material, and to determine the appropriate method of installing the grounding system (minimum copper or copper-clad of 5/8-inch diameter). The ground wire shall be connected in the meter socket or at the first point of attachment depending upon your operating companies’ requirements. The Customer shall have a minimum of 2 driven ground rods at least 6 feet apart, or else Customer grounding shall be in accordance with the NEC and the local or state authority.

The equipment grounding conductors should not be installed along with the service entrance conductors being installed to the secondary compartment of the Company’s pad-mount transformers.

Communication companies, such as telephone, satellite dish, and cable television, are forbidden to ground their systems to the meter enclosure.

Antioxidant compounds **SHALL NOT BE USED ON METER SOCKET BLADES OR METER BASE JAWS.**

	Guide for Electric Service and Meter Installations	Rev. 1.01	Page 23
	CAUTION: Printed copies of this document are uncontrolled and may be obsolete. Always check for the latest revision prior to use.		

Antioxidant compounds can be used on *aluminum conductors* and meter base terminal per the AHJ of your area.

## 8.0 METERING EQUIPMENT

---

### 8.1 Meter Location

The meter location is an important consideration to both the Customer and the Company. A point to be mutually agreed upon, the Customer shall provide a suitable location on his premises for the installation of the Company's meter and other equipment necessary for the Company to provide electric service. The service entrance shall be so arranged that the Company can measure the Customer's entire electric service with one meter, unless otherwise specified in the Company's rate tariff schedule.

Meters for service to both residential and commercial Customers shall be installed outdoors. No trees or shrubs shall be planted in front of the meter (NEC 110.26). In general, a location shall be such that it will not interfere with traffic, sidewalks, or driveways, nor obstruct the opening of doors or windows.

**The Meter and Service Guide contains general information and cannot address all variations in every installation. The Customer MUST contact their local AEP operating company for more details and the local operating company's requirements. Contact must be made prior to the design and installation of AEP-related equipment.**

No Customer or third-party equipment is allowed to be attached to the meter or to the associated metering equipment, nor located inside a meter or current transformer enclosure.

On types of service where outdoor installation is not practical, permission and specifications for indoor metering shall be obtained from the Company. The location shall be readily accessible as close as possible to the point where the service conductors enter the building, with the center of the meter being not more than 5 feet, 6 inches or less than 4 feet from the floor. For multiple meter packs, refer to Figure M.S.\_F019.

In general, meters shall not be installed above the first story level or below the first basement level of a building. Space and clearance requirements for indoor metering installations are the same as for outdoor metering.

Except for mobile home overhead services described in Section 5.2, meters will be mounted on poles or a meter rack only when no other means of mounting are feasible. When mounted on poles or a meter rack, all devices and methods of mounting will be specified by the Company.

	Guide for Electric Service and Meter Installations	Rev. 1.01	
	CAUTION: Printed copies of this document are uncontrolled and may be obsolete. Always check for the latest revision prior to use.		Page 24

## 8.2 Meter Sockets

All meter sockets installed in the Company's service territory shall be of a type approved by the Company and meet all requirements in construction and features. In addition, meter sockets purchased by the Customer shall be UL (Underwriters Laboratories)- or ETL (Electrical Testing Laboratories)- listed and labeled in accordance with the National Electrical Code. For a list of approved meter sockets refer to AEP's website.

AEP-approved **self-contained meter sockets** with the slide-in type terminals are tested by UL or ETL for a maximum number of termination points in their connection lugs. Requirements are, therefore, as follows:

### Self-Contained Meter Sockets, 200-amp rated or less:

- AEP shall not allow more than *one termination point* in the connection lug in all 200-amp self- contained meter bases/sockets.
- AEP's 200-amp underground socket shall have one set of concentric knockouts in bottom left for 3- inch conduit and be of the side wire/bused design for straight-in wiring. The left side will be for the line-side conductors and the right side for load-side conductors. (See Figure M.S.\_F008 Detail "A")
- Self-contained 200-amp 4-terminal meter sockets shall have provisions for a 5th terminal. When a 5th terminal is required, it shall be installed in the 9 o'clock position and securely tied to the neutral.
- All sockets shall have a double lay-in for the neutral connection.
- Bypass horns for utilities' use for manual bypass using jumper cables are required by the Company.
- These meter sockets shall be ringless style.
- The meter base is not intended to be modified as an interconnection point.
- *Customers should not access a sealed meter or CT enclosure.*

### Self-Contained Meter Sockets, 320-amp:

- AEP shall only allow **two termination points** in the connection lugs in the 320-amp self-contained meter bases/sockets, which are designed for such applications.
- All connection lugs must be UL- or ETL-approved and approved by the manufacturer for the specific application and units.
- AEP's 320-amp underground socket shall have one set of concentric knockouts in bottom left for 4- inch conduit and be of the side wire/bused design for straight in wiring. The left side will be for the line conductors and the right side for load conductors.

	Guide for Electric Service and Meter Installations	Rev. 1.01	
	CAUTION: Printed copies of this document are uncontrolled and may be obsolete. Always check for the latest revision prior to use.		Page 25

### Additional Requirements:

- 200-amp 4-terminal commercial meter sockets shall have a good quality jaw release manual operated bypass which is 100% rated.
- 200 amp 5- and 7-terminal, and all 320-amp meter sockets, shall have a good quality jaw release manual operated bypass which is 100% rated.
- Meter sockets, multi-gang sockets, and meter pedestals will be ringless style.
- *Customers should not access a sealed meter or CT enclosure.*
- In AEP Service Territory, meter sockets used on a commercial Customer shall have a lever-operated bypass device for three phase and single phase (Figures M.S.\_F001, M.S.\_F002, M.S.\_F003, M.S.\_F006, and M.S.\_F008)
- ***In AEP West 100-amp meter sockets are not permitted.***
- Repairs to meter sockets are the responsibility of the Customer. If repairs cannot restore the socket to its standard condition, the Customer shall be notified in writing to replace the damaged meter socket within (30) thirty days to avoid a disconnection of service.
- The Company may in the interests of safety and efficiency, and at its sole discretion, make minor repairs to meter sockets.
- Antioxidant compounds **SHALL NOT BE USED ON METER SOCKET BLADES OR METER BASE JAWS.**
- Antioxidant compounds can be used on *aluminum conductors* and meter base terminal per the AHJ of your area.

## 8.3 Meter Identification on Multi-Occupancy Buildings

On multi-occupancy buildings, all meter sockets (including the inside of the socket and cover), and main service disconnect switches shall be plainly and permanently marked with numbers and/or letters by the owner so as to indicate the building address or apartment address served. The markings must be either engraved phenolic nameplates or adhesive-type labels at least one inch wide. Felt tip pens and label maker tape are not considered permanent marking. Service will not be established until marking is complete. The Company will assume no responsibility for inspecting the Customer's equipment, or the accuracy of matching premises location as indicated on the meter socket and main service disconnect switch but shall have the right to verify itself that the service is certified by the local inspection authorities and that it is safe to connect.

	Guide for Electric Service and Meter Installations	Rev. 1.01	
	CAUTION: Printed copies of this document are uncontrolled and may be obsolete. Always check for the latest revision prior to use.		Page 26

## 8.4 Relocation of Service and Meter Equipment

Whenever it becomes necessary to relocate the service entrance and meter equipment of an existing installation, the Company shall be consulted before such work is begun. The Company shall attempt to minimize interruption of service during the changeover period. Where applicable, additional charges may be necessary for relocation of, or changes to, power facilities serving the Customer, especially if the work is performed at the Customer's request and for the Customer convenience.

## 8.5 No Connections Allowed Ahead of Metering Devices

The connection of any Customer-owned apparatus or device to the service conductors ahead of the Company-owned meters or to the meter socket without Company authorization is expressly forbidden. All 480-volt self-contained meter installations (see Figure M.S.\_F015), require the installation of a non-fused load break disconnect switch (provided and installed by Customer) ahead of the meter socket for the safety of Company's employees. The line-side disconnect must be lockable and will be exclusively operated by the Company.

An exception to this practice is when the authority having jurisdiction (AHJ) will not permit a non-fused disconnect switch.

The meter socket/current transformer enclosure/cabinet shall not be used as a junction box.

## 8.6 Seals

All enclosures containing un-metered conductors shall be capable of being effectively sealed by the Company.

The breaking of seals by other than authorized persons or tampering with the Company's meters and measuring devices is prohibited. Where the Company detects that the physical facilities of the Company have been tampered with so as to cause an unauthorized use of electric energy or loss of meter registration, the Company may at any time and without notice discontinue the supply of electric energy to the Customer and remove its meter and other apparatus until such time as the customer has corrected the condition to the satisfaction of the Company. Such tampering could result in criminal actions, depending upon applicable state laws.

## 8.7 Energy Management

The Company recommends that the Customer who is contemplating the installation of demand or energy control equipment contact the Company prior to installing such equipment.

At the Customer's request, the Company will furnish energy and/or time pulses. The Customer will be charged for the installation costs to supply these pulses.

	Guide for Electric Service and Meter Installations	Rev. 1.01	
	CAUTION: Printed copies of this document are uncontrolled and may be obsolete. Always check for the latest revision prior to use.		Page 27

The Customer's or third-party load monitoring equipment must be installed only on the load side of the meter. No customer or third-party equipment is allowed to be attached to the meter, associated metering equipment, nor located inside a meter or current transformer enclosure.

## 8.8 Underground Service with Current Transformer Metering

Current transformers shall not be mounted in a single-phase pad mounted transformer due to clearances between phases and ground and for the safety of Company personnel. A separate current transformer enclosure shall be required in this case.

Current transformers may be mounted on the secondary bushings of a three-phase pad mounted transformer if only one metered service is planned, and the Operating Company Engineer/Technician confirms that no future services will be fed from the same transformer. As shown in Figures M.S.\_F013 and M.S.\_F014, the customer shall install the transformer rated meter socket within 25 feet of the transformer on the building or on a structure adjacent to the transformer.

Current transformers will not be mounted in a three-phase pad mounted transformer if there is to be more than one metered service provided from the transformer. An enclosure must be provided for each separately metered service.

## 8.9 Separately Metered Electric Vehicle Service

A customer can take advantage of a "Time of Use" rate for charging an electric vehicle during off-peak hours by installing a second meter socket or a two-gang meter socket. See Figure M.S.\_F022 for details.

# 9.0 CUSTOMER'S SERVICE EQUIPMENT

---

## 9.1 General

Each Point of Delivery shall have a single disconnecting means that will disconnect all non-grounded Customer conductors from the AEP system. This disconnecting means shall be located as close as possible to the Point of Delivery and be readily accessible.

## 9.2 Service Equipment Rating

Service entrance conductors and the service equipment on residential buildings should have a rating of not less than 100 amperes in AEP East and 200 amperes in AEP West, 120/240 volts, three-wire, or have an electrical rating large enough to accommodate the initial electrical load plus anticipated future needs. The equipment interrupting rating shall exceed the fault availability as determined by the Company as required by the NEC.

	Guide for Electric Service and Meter Installations	Rev. 1.01	
	CAUTION: Printed copies of this document are uncontrolled and may be obsolete. Always check for the latest revision prior to use.		Page 28

All fuses and circuit breakers shall be provided by the Customer and shall be of suitable capacity to protect the wiring installation and utilization equipment connected thereto. Circuit protective devices shall not have a rating higher than the current carrying capacity of the conductors that they protect, except where it is necessary to provide for motor starting currents. "Time delay" or "time lag" fuses or circuit breakers are recommended for protection of branch circuits supplying motor-driven devices.

It is not permissible to fuse or switch the grounded neutral conductor of a grounded system. The customer shall consult the latest edition of the NEC and other local codes for applicable requirements.

### 9.3 Customer-Owned Current Transformer (CT) Enclosures Specifications

Contact your local AEP office's Metering department for approval before installation.

#### Construction

In non-corrosive environments, steel enclosures may be used. Steel enclosures shall be a minimum of G-90 galvanized steel. All edges shall be smooth after forming. The enclosure shall be painted after fabrication. Finish coat shall be a minimum of 2 mils in thickness and provide a tough, non-chalking, weather resistant finish. Construction shall be in accordance with ANSI/UL50. Outdoor enclosures shall be rated Type 3R. The current transformer enclosure shall be fitted with hinged door(s) and sealing shall be provided by a minimum grade 304 stainless steel latch and rivet with provision for 3/8-inch padlock and/or ribbon seal. The inside back of enclosure shall be entirely covered by 3/4-inch treated plywood or suitable mounting brackets must be provided. A grounding lug shall be provided to ground the enclosure.

#### Protection

Enclosures shall be designed to protect personnel against accidental contact with the electrical devices and guard against unauthorized use of electric service. They cannot be opened without either breaking the seal or visibly damaging the enclosure.

#### Corrosive Environments

Aluminum- or fiber-reinforced polyester enclosures must be used in corrosive environments. Corrosive environments include all installations within 30 miles of the Texas Gulf of Mexico coast and installations in any other area where high moisture or chemical exposure may exist, such as chemical plants or water treatment plants. Enclosure construction shall be in accordance with ANSI/UL50. Outdoor enclosures shall be rated Type 3R. Current transformer enclosures shall be

	Guide for Electric Service and Meter Installations	Rev. 1.01	Page 29
	CAUTION: Printed copies of this document are uncontrolled and may be obsolete. Always check for the latest revision prior to use.		

fitted with hinged door(s) and sealing shall be provided by high-strength stainless steel latch with provision for 3/8-inch padlock and/or ribbon seal. Exposed hinges and hardware shall be minimum grade 316 stainless steel or better. Other methods of sealing may be acceptable but must be approved by the Company prior to being utilized. The inside back of the enclosure shall be entirely covered with back plate and/or suitable mounting brackets must be provided. An enclosure ventilator is required. A grounding lug shall be provided to ground the enclosure.

*Exceptions to this requirement of Aluminum Construction may be allowed in a case-by-case situation, due to current supply chain issues. Please Contact your AEP Representative for more information.*

**Note: AEP shall not be held responsible for the increased deterioration of components and shorter component life of equipment due to these exceptions, where granted.**

## 9.4 Customer-Owned Enclosures

All Customer-owned metering troughs, switchgear, gutters containing un-metered conductors, and metering equipment must have prefabricated provisions for sealing by AEP Meter personnel. The Customer or electrician shall contact AEP to obtain access for inspection.

Nothing shall be attached to the meter, meter enclosure, current transformer enclosure, or to the associated metering equipment that would inhibit AEP personnel from reading the meter, changing or testing the metering equipment, performing routine maintenance, etc. Customer-owned equipment shall only be installed on the load side of any meter.

At the discretion of the operating company, for service requiring large numbers of feeders a secondary termination cabinet may be required.

## 9.5 Surge Protection Requirement

See Section 4.11 – Surge Protection Requirement

	Guide for Electric Service and Meter Installations	Rev. 1.01	
	CAUTION: Printed copies of this document are uncontrolled and may be obsolete. Always check for the latest revision prior to use.		Page 30

## 10.0 CUSTOMER'S UTILIZATION EQUIPMENT

---

### 10.1 General

All customer utilization equipment must be designed for operation on alternating current at a nominal frequency of 60 Hertz.

Customers installing power factor correction apparatus shall consult the Company to ensure that such apparatus will have suitable characteristics to accomplish the desired results.

Customer MUST contact the local AEP operating company for more details and the local operating company's requirements. Contact must be made prior to the design and installation of AEP-related equipment.

In general, the Company shall be notified before any significant new load is added to ensure that adequate capacity is available. This includes air conditioning and heat pumps.

### 10.2 Voltage Fluctuation and Flicker Limits

Welders, X-ray equipment, motors, power electronic equipment or other equipment, the load of which is of such a character as to cause major voltage fluctuations, voltage flicker, and significant wave form distortion or system overloads, are subject to individual consideration and approval by the Company. Where such equipment is used, the Customer may be required, at their expense, to install corrective devices or apparatus, or may be requested to limit the operation of this equipment in order to prevent disturbances caused by such equipment from affecting service to other customers. Objectionable fluctuations result from the combination of the magnitude of the fluctuation and the frequency of occurrence of the fluctuations. Other disturbances may include equipment misoperation and possible damage to other customers' equipment or process.

In order to avoid misunderstanding and inconvenience, the Customer or their electrical contractor should consult the Company before purchasing motors or any other devices of the character mentioned above. Additionally, there may be specific Public Service Commission requirements and/or industry standards that may be required to be met that will alleviate possible adverse effects to other services or equipment. Even in cases where the Company gives prior permission, it cannot give absolute assurance that the installation will not later require changes in order to maintain proper service, if either the information provided earlier was not accurate or if changes have occurred in customer load.

### 10.3 Current/Voltage Harmonic Distortion Limits

In accordance with IEEE standard 519, for all customers whose delivery voltage is less than 69 kV, the following limits apply with regard to harmonic distortion that can occur from non-linear loads such as variable speed motors, arc furnaces, rectifiers, low wattage electric lights, and other electronic loads.

	Guide for Electric Service and Meter Installations	Rev. 1.01	
	CAUTION: Printed copies of this document are uncontrolled and may be obsolete. Always check for the latest revision prior to use.		Page 31

These limitations are located at the point of common coupling where the Customer and the Company systems interface.

- For Current Distortion, the *Total Demand Distortion (TDD)* limit can range from **5% to 20%**. This is determined by the ratio of short circuit strength of the electrical system in relation to the yearly average peak load.
- For Voltage Distortion, the *Total Harmonic Distortion (THD)* limit is **8% for a Point of Common Coupling (PCC) serving multiple users and 5% for serving a singular user.**
- Individual harmonic component levels for both current and voltage are required to be lower than the IEEE 519 limits.

It is recommended that the Customer consult the Company if these total limits are exceeded or if the Company requires assistance in determining the acceptable harmonic levels. The company can provide recommendations for mitigation of unacceptable harmonic levels contributed by Customer load.

## 10.4 Protection For Voltage-Sensitive Equipment

The Customer shall provide and maintain suitable protective devices on their equipment to prevent any loss, injury or damage that might result from single-phasing conditions or any other fluctuation or irregularity in the supply of energy.

To prevent possible equipment failure and data loss, computers, programmable controllers, and other voltage-sensitive digital devices should be protected against abnormal system conditions by using commercially available AC line conditioners, surge suppressors, or uninterruptible power supplies to provide a constant power source to these devices.

## 10.5 Motors

All motor installations should be provided with devices that will protect the motor and motor circuit against overload and short circuit. In addition, three-phase motors should be protected against single-phase operation. All motors that 1) cannot be safely subjected to full voltage at starting, and 2) are not equipped with a means of automatic restarting, should be provided with a device to ensure that upon failure of supply voltage, the motor will be disconnected from the line or the starting device returns to the "off" position. To prevent unnecessary shutdowns, it is recommended that this "no voltage release" device be equipped with a time delay feature so that it will not function until the motor speed drops to a point where it will not pick up on a restoration of service.

All equipment and motor frames are to be grounded using a grounding conductor according to the NEC or be double insulated.

	Guide for Electric Service and Meter Installations	Rev. 1.01	
	CAUTION: Printed copies of this document are uncontrolled and may be obsolete. Always check for the latest revision prior to use.		Page 32

Refer to the NEC for the requirements for motor circuits and controllers. Wire sizing and limitations can also be found in the NEC. Always consult the motor manufacturer before making any modifications to a motor’s protection or starting equipment.

## 11.0 EMERGENCY DISCONNECTS

---

All operating companies enforcing NEC 2020 or later shall employ emergency disconnects as per NEC article 230.85.

### Requirements

For one- and two-family dwelling units, all service conductors must terminate in a disconnecting means having a short-circuit current rating greater than or equal to the available fault current, and be installed in a readily-accessible outdoor location. If more than one disconnect is provided, these disconnects must be grouped. Each disconnect must be one of the following:

1. Service disconnects, marked as: EMERGENCY DISCONNECT, SERVICE DISCONNECT
2. Meter disconnects installed in accordance with NEC 230.82(3), which must be marked: EMERGENCY DISCONNECT, METER DISCONNECT, NOT SERVICE EQUIPMENT
3. Other listed disconnect switches or circuit breakers on the load side of the meter and supply side of each service disconnect, marked: EMERGENCY DISCONNECT, NOT SERVICE EQUIPMENT

Marking must be permanently affixed and be sufficiently durable to withstand the environment involved, in accordance with NEC 110.21(E).

## 12.0 DISTRIBUTED ENERGY RESOURCES (DER)

---

### 12.1 Basic Residential DER system with Production meter

DER facility revenue metering is required by AEP for all Customers. To achieve this requirement, AEP will provide and deploy appropriate facility revenue metering for each DER installation based on the proposed configuration of the DER and its intended purpose, state-specific or regional tariff requirements, and AEP’s own internal requirements. AEP strives to directly measure and capture the energy produced and consumed by a connected DER through standardized metering equipment.

AEP will determine the appropriate site-specific DER facility revenue metering requirements as part of the DER interconnection process. This section represents a simple DER system setup without any type of energy storage system (ESS).

Figure M.S.\_F008A represents a possible installation (not a required method of installation) that meets AEP’s requirements for the wiring and placement of the PoC meter.

	Guide for Electric Service and Meter Installations	Rev. 1.01	
	CAUTION: Printed copies of this document are uncontrolled and may be obsolete. Always check for the latest revision prior to use.		Page 33

## 12.2 Application Submission

Prior to beginning construction of the DER facility, a DER interconnection request shall be submitted via AEP's online PowerClerk portal: <https://aep.powerclerk.com/MvcAccount/Login>.

Customer shall follow the interconnection process as detailed in Section 12 of AEP's *Technical Interconnection and Interoperability Requirements (TIIR) for the AEP Distribution System*: [DER Technical Interconnection and Interoperability Requirements \(TIIR\) for the AEP System](#).

## 12.3 Point of Connection (PoC) Meter Socket

Depending on state tariffs and planned DER operation, the Customer may be responsible for installing a point of connection (PoC) meter, sometimes referred to as a production meter. The purpose of this meter is to measure the generation of the DER unit(s). PoC meter socket requirements are as follows:

- The Customer shall be responsible for the installation of the meter socket.
- The meter socket shall be purchased by the Customer, except in areas where the Operating Company provides this component.
- No additional equipment shall be installed inside the meter socket.
- Connection within the meter socket shall only be done using manufacturer-specified equipment.
- The meter socket shall comply with meter location requirements identified in Section 8.1.
- The meter socket shall be installed outdoors in a readily accessible location; no trees or shrubs shall be planted in front of the meter.
- The meter socket shall be installed with metal or lead anchors only. Plastic anchors are not acceptable.
- Entrance and exit conduits shall be installed using the manufacturer's knockout holes.
- The area 15" on each side of and 48" in front of the meter socket shall be clear of obstructions.
- The neutral shall not be bonded to the ground in the meter socket.
- The PoC meter socket shall be bonded.
- The meter socket shall follow all rules and requirements listed elsewhere in this guide.

	Guide for Electric Service and Meter Installations	Rev. 1.01	
	CAUTION: Printed copies of this document are uncontrolled and may be obsolete. Always check for the latest revision prior to use.		Page 34

## 12.4 DER Disconnect

The customer shall provide and install a readily accessible, visible-break isolation device that shall be located between the area EPS (Electrical Power System) and each DER for all installations.

The DER facility shall comply with AEP's full isolation device requirements found in Sections 4.9 and 4.10 of the Company's TIIR document.

## 12.5 General Instructions

*Where the operating company requires them, AEP shall provide, own, and install the billing and PoC meters.*

Any required telemetry equipment shall be installed as agreed upon within the Interconnection Service Agreement.

The Customer shall be responsible for the installation and maintenance of all other DER equipment.

The Customer shall be responsible for ensuring compliance with all AHJ and NEC requirements and codes.

## 12.6 Completion and Inspection

A complete guide to AEP's commissioning and verification requirements can be found in Section 13 of the TIIR document.

AEP will install a bi-directional billing meter and a PoC meter once the system has passed inspection and all required paperwork is complete.

The system **shall not** operate in parallel with AEP's grid until the "Permission to operate letter" has been received.

## 12.7 Conditionally Acceptable Winding Configurations

Ground continuity is a major design concern for interconnecting DER installations. To ensure ground continuity between the Company's four-wire grounded-wye grid and an interconnecting DER, generation from the Customer's equipment is generally required to be grounded, with a strong preference for grounded-wye Customer generation. The following transformer-winding configurations may be acceptable for the service transformer connection between a DER and AEP's four-wire grounded-wye Distribution System, *pending results of the appropriate screen or study.*

- 
- Grounded Wye to Grounded Wye<sup>1</sup>
  - Grounded Wye to Delta<sup>2</sup>

	Guide for Electric Service and Meter Installations	Rev. 1.01	Page 35
	CAUTION: Printed copies of this document are uncontrolled and may be obsolete. Always check for the latest revision prior to use.		

- Grounded Wye to Reactor-Grounded Wye

<sup>1</sup> If the generation is ungrounded wye or delta connected, additional transformers are required between the service transformer and DER. If the generation is grounded wye, the ground must be carried through to the generator.

<sup>2</sup> Only allowed for Customer-owned service transformers for primary delivery.

Grounding these transformers with a reactive element in series has the effect of reducing fault current compared to use of solid grounding (ground rod) which will absorb maximum fault current.

## 12.8 Prohibited Cases

Provided below is a list of cases where the type of Service or the nature of the Production equipment prohibits the latter’s connection in a DER installation back into AEP’s grid. *This section is not intended to cover all instances where certain energy production equipment shall **not** be used in a DER installation.*

- For residential sites, Production equipment shall not be installed for interconnection with AEP’s grid when the service is of ungrounded Delta type.
  - This is because, as mentioned in the previous section, ungrounded Delta interconnections requires additional transformers between the service transformer and the DER system, which itself requires metering equipment not designed for residential applications.

## 13.0 EV (Electric Vehicles)

NEC Article 625 contains several sections requiring listing for equipment used to charge plug-in hybrid-electric vehicles and electric vehicles. Some of the key sections include:

- Section 625.5 — Requires listing of all electrical materials, devices, fittings, and associated equipment.
- Section 625.18 — Requires that EV supply equipment includes an interlock that de-energizes an electric vehicle connector and its cable whenever a connector is uncoupled from an electric vehicle.
- Section 625.19 — Requires that EV supply equipment have a means to automatically de-energize the cable conductors and electric vehicle connector upon exposure to strain that could result in cable rupture or separation of a cable from the electric connector and expose live parts.
- Section 625.22 — Requires that the electric vehicle supply equipment have a listed system to protect users from electric shock.

	Guide for Electric Service and Meter Installations	Rev. 1.01	
	CAUTION: Printed copies of this document are uncontrolled and may be obsolete. Always check for the latest revision prior to use.		Page 36

## 14.0 ESS (Energy Storage Systems)

---

### 14.1 Energy Storage System

ESS for one- and two-family dwelling units shall not exceed 100 volts DC between conductors or to ground.

*Per NEC 706.20(B) Exception: Where live parts are not accessible during routine ESS maintenance, a maximum ESS voltage of 600 volts DC shall be permitted.*

ESSs shall comply with NEC Sections 110.26 and 110.34.

A disconnecting means shall be provided for all ungrounded conductors derived from an ESS and shall be permitted to be integral to listed ESS equipment.

The disconnecting means shall comply with all the following:

1. The disconnecting means shall be readily accessible.
2. The disconnecting means shall be located within sight of the ESS. Where it is impractical to install the disconnecting means within sight of the ESS, the disconnect shall be installed as close as is practical, and the location of the disconnecting means shall be field-marked on or immediately adjacent to the ESS. The marking shall be of sufficient durability to withstand the environment involved and shall *not* be handwritten.
3. The disconnecting means shall be lockable open, in accordance with NEC 110.25.

### 14.2 Notification and Marking

Each ESS disconnecting means shall plainly indicate whether it is in the open (off) or closed (on) position and be permanently marked “ENERGY STORAGE SYSTEM DISCONNECT”. The disconnecting means shall be legibly marked in the field to indicate the following:

1. Nominal ESS AC voltage and maximum ESS DC voltage
2. Available fault current derived from the ESS
3. An arc-flash label applied in accordance with acceptable industry practice.
4. Date the calculation was performed.

*Exception: List items (2), (3), and (4) shall not apply to one- or two-family dwellings.*

Industry practices for equipment labeling is described in NFPA 70E2018, Standard for Electrical Safety in the Workplace. This standard provides specific criteria for developing arc-flash labels for equipment that provides nominal system voltage, incident energy levels, arc-flash boundaries, minimum required levels of personal protective equipment, etc.

	Guide for Electric Service and Meter Installations	Rev. 1.01	Page 37
	CAUTION: Printed copies of this document are uncontrolled and may be obsolete. Always check for the latest revision prior to use.		

## 15.0 Emergency Stand-By Generators

---

The Company shall be notified of the Customer's intention to install an Emergency Stand-By Power System (ESS). In such cases, Company investigation shall ensure the proper procedures to eliminate any back feed to the Company's power system that may result in endangering the public and/or Company personnel and damage to Company or Customer property. The transfer equipment installed with emergency stand-by generators shall be installed in accordance with the NEC.

## 16.0 Portable Generators

---

A positive method of isolating Company power circuits from the generator circuits must be provided. The following hazards exist which require that different power sources be isolated:

1. Electrocution of Company personnel can result if the generator circuit is not properly isolated from the electric utility power circuit.
2. If generator and utility power are not isolated from each other and utility power is restored while the generator is supplying power, utility power can back feed through the generator. Damage to the generator and a possible electrical fire can result.
3. Portable generators must be sized and connected to the load in accordance with all applicable codes and the manufacturer's recommendation.

	Guide for Electric Service and Meter Installations	Rev. 1.01	
	CAUTION: Printed copies of this document are uncontrolled and may be obsolete. Always check for the latest revision prior to use.		Page 38

## 17.0 Figures

---

M.S._F001 – TEMPORARY SERVICE INSTALLATION FROM EXISTING URD SECONDARY .....	41
M.S._F002 – ALTERNATE TEMPORARY SERVICE INSTALLATION FROM EXISTING URD SECONDARY .....	42
M.S._F003 – TEMPORARY SERVICE INSTALLATION FROM EXISTING OVERHEAD SECONDARY .....	43
M.S._F004 – SINGLE MOBILE HOME OVERHEAD SERVICE .....	44
M.S._F005 – SERVICE DROP CABLE CLEARANCES FOR DUPLEX, TRIPLEX, AND QUADRUPLEX CONDUCTORS .....	45
M.S._F006 – SERVICE ATTACHMENT TO MAST OF LOW PROFILE OR OTHER BUILDING .....	46
M.S._F007 – SERVICE DROP ATTACHMENTS AT BUILDING .....	47
M.S._F008 – SINGLE PHASE UNDERGROUND SERVICE METER INSTALLATION .....	48
M.S._F008A – RESIDENTIAL DER SYSTEM WITH “PRODUCTION METER” DETAILS .....	49
M.S._F009 – SINGLE MOBILE HOME UNDERGROUND SERVICE .....	50
M.S._F009A – SINGLE MOBILE HOME UNDERGROUND SERVICE (ALTERNATE METER PEDESTAL) .....	51
M.S._F010 – CURRENT TRANSFORMER CABINETS OVERHEAD OR UNDERGROUND SERVICE WINDOW-TYPE CTS.....	52
M.S._F011 – CURRENT TRANSFORMER CABINETS OVERHEAD OR UNDERGROUND SERVICE WINDOW-TYPE CTS AND VTS 277/480 VOLT .....	53
M.S._F011B – CURRENT TRANSFORMER CABINETS OVERHEAD OR UNDERGROUND SERVICE WINDOW-TYPE CTS AND VTS 277/480 VOLT .....	54
M.S._F012 – CURRENT TRANSFORMER CABINET FREESTANDING OVERHEAD TO UNDERGROUND SERVICE .....	55
M.S._F012B – CURRENT TRANSFORMER CABINET FREE-STANDING OVERHEAD TO UNDERGROUND SERVICE ALTERNATE METER INSTALLATION.....	56
M.S._F013 – PAD-MOUNT TRANSFORMER METERING INSTALLATION .....	57
M.S._F014 – METER INSTALLATION FROM PAD-MOUNT TRANSFORMER USING BUSHING-TYPE CTS .....	58
M.S._F014B – METER INSTALLATION FROM PAD-MOUNT TRANSFORMER TO METER ENCLOSURE W/ VT PACK 480V.....	59
M.S._F015 – 480V SELF-CONTAINED METERING SERVICES (200A MAX) .....	60
M.S._F016 – THREE PHASE SELF-CONTAINED METER SOCKET.....	61
M.S._F017 – BOLTED CONNECTOR ASSEMBLIES.....	62

	Guide for Electric Service and Meter Installations	Rev. 1.01	
	CAUTION: Printed copies of this document are uncontrolled and may be obsolete. Always check for the latest revision prior to use.		Page 39

M.S.\_F018 – MULTIPLE METER INSTALLATION ..... 63

M.S.\_F019 – PRE-ASSEMBLED MULTIPLE METER INSTALLATION..... 64

M.S.\_F020 – METER CLEARANCES..... 65

M.S.\_F020A – CT CABINET AND METER EQUIPMENT CLEARANCES GROUND-LEVEL INSTALLATION ..... 66

M.S.\_F021A – TYPICAL OVERHEAD CT CABINET AND METER EQUIPMENT CATWALK INSTALLATION WALL MOUNT ABOVE FLOOD LEVEL WITH PLATFORM..... 67

M.S.\_F021B – TYPICAL OVERHEAD METER EQUIPMENT SELF-STANDING PLATFORM INSTALLATION POLE MOUNT ABOVE FLOOD LEVEL ..... 68

M.S.\_F022 – METER SOCKET LAYOUT FOR ADDING A SEPARATELY-METERED ELECTRIC VEHICLE SERVICE..... 69

M.S.\_F023 – SELF-CONTAINED METER SOCKET CONNECTIONS (SINGLE PHASE AND NETWORK)..... 70

M.S.\_F024 – SELF-CONTAINED METER SOCKET CONNECTIONS (THREE WIRE AND FOUR WIRE DELTA).... 71

M.S.\_F025 – SELF-CONTAINED METER SOCKET CONNECTIONS (THREE & FOUR WIRE WYE)..... 72

M.S.\_F026 – SINGLE FREE-STANDING STRUCTURE OVERHEAD SERVICE ..... 73

M.S.\_F027 – SINGLE FREE-STANDING STRUCTURE UNDERGROUND SERVICE ..... 74

M.S.\_F027A – SINGLE FREE-STANDING STRUCTURE UNDERGROUND SERVICE (ALTERNATE METER PEDESTAL) ..... 75

M.S.\_F028 – CURRENT TRANSFORMER CABINET, FREE STANDING, OVERHEAD, WINDOW-TYPE CTS (WITH VT ISOLATION CABINET/METER SOCKET COMBINATION ..... 76

STRUC-65.1 – 480V DELTA OR 277/480V WYE, 200A & BELOW SELF-CONTAINED METER W/ METER DISCONNECT ..... 77

STRUC-65.2 – CURRENT TRANSFORMER CABINET, FREE STANDING, OVERHEAD, WINDOW-TYPE CTS..... 78

STRUC-65.3 – CURRENT TRANSFORMER CABINET, FREE-STANDING, OVERHEAD, WINDOW-TYPE CTS (NOTES) ..... 79

	Guide for Electric Service and Meter Installations	Rev. 1.01	
	CAUTION: Printed copies of this document are uncontrolled and may be obsolete. Always check for the latest revision prior to use.		Page 40

AMERICAN ELECTRIC POWER COMPANY  
METER STANDARDS

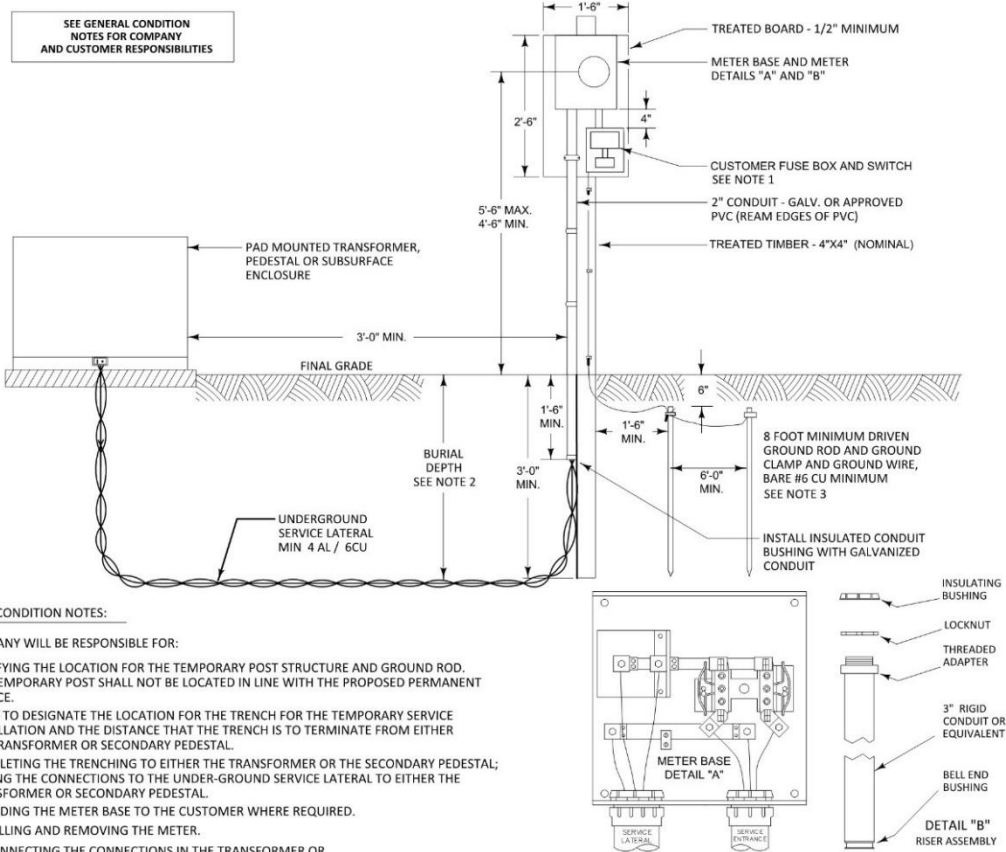

GENERAL CONDITION NOTES:

THE COMPANY WILL BE RESPONSIBLE FOR:

- SPECIFYING THE LOCATION FOR THE TEMPORARY POST STRUCTURE AND GROUND ROD. THE TEMPORARY POST SHALL NOT BE LOCATED IN LINE WITH THE PROPOSED PERMANENT SERVICE.
- AEP IS TO DESIGNATE THE LOCATION FOR THE TRENCH FOR THE TEMPORARY SERVICE INSTALLATION AND THE DISTANCE THAT THE TRENCH IS TO TERMINATE FROM EITHER THE TRANSFORMER OR SECONDARY PEDESTAL.
- COMPLETING THE TRENCHING TO EITHER THE TRANSFORMER OR THE SECONDARY PEDESTAL; MAKING THE CONNECTIONS TO THE UNDER-GROUND SERVICE LATERAL TO EITHER THE TRANSFORMER OR SECONDARY PEDESTAL.
- PROVIDING THE METER BASE TO THE CUSTOMER WHERE REQUIRED.
- INSTALLING AND REMOVING THE METER.
- DISCONNECTING THE CONNECTIONS IN THE TRANSFORMER OR SECONDARY PEDESTAL AND REMOVING THE METER.

THE CUSTOMER WILL BE RESPONSIBLE FOR:

- PROVIDING AND INSTALLING THE TEMPORARY STRUCTURE; FUSE BOX AND SWITCH; CONDUIT; UNDERGROUND SERVICE LATERAL AND CABLE TERMINAL LUGS (IF NEEDED); GROUND ROD; GROUND CLAMP; AND GROUND WIRE. SERVICE LATERAL PROVIDED BY THE COMPANY WHERE REQUIRED BY GOVERNMENTAL REGULATION.
- CUSTOMER TO TRENCH THE DESIGNATED DISTANCE BETWEEN THE TEMPORARY POST AND THE COMPANY'S TRANSFORMER OR PEDESTAL. CUSTOMER TO DETERMINE LOCATION OF ALL UTILITIES BEFORE TRENCHING.
- PROVIDING WEATHERPROOF (OR COVERED) SERVICE ENTRANCE EQUIPMENT (UL LISTED WITH FUSED DISCONNECT SWITCH OR CIRCUIT BREAKER - 3 WIRE). EQUIPMENT SHALL BE SIZED AS REQUIRED AND MOUNTED ON A BOARD BASE.
- SECURELY MOUNTING THE METER BASE IN A PLUMB POSITION.
- MAKING ALL CONNECTIONS IN THE METER SOCKET.
- PROVIDING THE INSPECTION IF NECESSARY. INSTALLATION OF EQUIPMENT TO BE IN ACCORDANCE WITH COMPANY STANDARDS AND / OR LOCAL ORDINANCES OR CODES.
- THE REMOVAL OF EQUIPMENT AFTER BEING DISCONNECTED.

GENERAL CONSTRUCTION NOTES:

- CUSTOMER FUSE BOX AND SWITCH MAY REQUIRE CURRENT LIMITING FUSES TO COMPLY WITH LOCAL CODES.
- BURIAL DEPTH IS THE DISTANCE BETWEEN FINAL GRADE AND THE TOP OF THE BURIED CABLE OR CONDUIT. THE POWER COMPANY (AEP) SHALL SPECIFY THE REQUIRED BURIAL DEPTH PER OPERATING COMPANY AS PRESCRIBED IN THE PROCEEDING LIST:

COMPANY	BURIAL DEPTH
APCO	= REQUIRES A BURIAL DEPTH OF 30"
KYPCO	= REQUIRES A BURIAL DEPTH OF 30"
I&M	= REQUIRES A BURIAL DEPTH OF 30"
OHIO	= REQUIRES A BURIAL DEPTH OF 30"
TEXAS	= REQUIRES A BURIAL DEPTH OF 36"
PSO	= REQUIRES A BURIAL DEPTH OF 36"
SWPCO	= REQUIRES A BURIAL DEPTH OF 36"

- AND/OR CONFORM TO ANY OR ALL AUTHORITY HAVING JURISDICTION. THE POWER COMPANY (AEP) HAS PRESCRIBED THE BURIAL DEPTH SHALL NOT BE LESS THAN STATED DEPTH ON THE PRECEDING LIST UNLESS IMPOSSIBLE TO BE ACHIEVED OR IS SUPERSEDED BY LOCAL AUTHORITY HAVING JURISDICTION. IF THE DEPTH IS IMPOSSIBLE TO ACHIEVED AEP'S VERIFICATION WILL BE NEEDED. HOWEVER, BURIAL DEPTH NOT TO BE LESS THAN WHAT IS STATED IN THE NATIONAL ELECTRICAL CODE'S ARTICLES AND TABLES: ARTICLE 300.3(B) (1), 300.3 (C) (1) (2), TABLE 300.5, AND TABLE 300.50
- CUSTOMER GROUNDING SHALL BE IN ACCORDANCE WITH NATIONAL ELECTRIC CODE. IN ARKANSAS, OKLAHOMA, LOUISIANA AND TEXAS, THE GROUNDING WIRE SHALL BE CONNECTED TO THE UTILITIES NEUTRAL IN THE METER SOCKET. THE CUSTOMER SHALL HAVE A MINIMUM OF 2 DRIVEN GROUND RODS AT LEAST 6 FEET APART OR MUST MEET THE NEC GROUNDING REQUIREMENTS.
- METER SOCKET USED ON COMMERCIAL CUSTOMER SHALL HAVE A LEVER OPERATED JAW RELEASE BY-PASS FOR THREE PHASE AND SINGLE PHASE.
- ANTI-OXIDANT COMPOUNDS **SHALL NOT BE USED ON METER SOCKET BLADES OR METER BASE JAWS.**  
ANTI-OXIDANT COMPOUNDS CAN BE USED ON ALUMINUM CONDUCTORS AND METER BASE TERMINAL PER THE AHJ OF YOUR AREA.
- PLEASE CHECK WITH YOUR LOCAL AHJ (AUTHORITY HAVING JURISDICTION) TO VERIFY WHETHER YOU ARE REQUIRED TO INSTALL A FULL SERVICE SURGE PROTECTION PER NEC 2020.

**FOR FURTHER INFORMATION ON UTILITY REQUIREMENTS PLEASE CONTACT YOUR LOCAL AEP OPERATING COMPANY.**

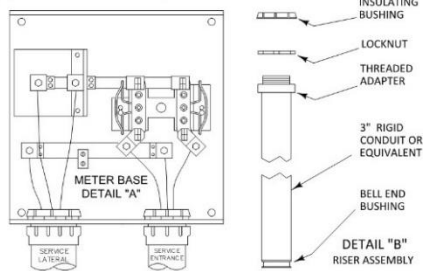

TEMPORARY SERVICE INSTALLATION  
FROM EXISTING URD SECONDARY

AMERICAN ELECTRIC POWER COMPANY  
METER STANDARDS

GENERAL CONSTRUCTION NOTES:

- SERVICE ENTRANCE CONDUCTORS SHALL PROJECT FROM WEATHERHEAD A MINIMUM OF 18 INCHES.
- USE 1/4" HOT DIPPED GALVANIZED LAG SCREWS OR MACHINE BOLTS TO SECURE SUPPORT STRUCTURE. IN CORROSIVE AREAS SUBSTITUTE WITH STAINLESS STEEL HARDWARE.

TEMPORARY SERVICE DROP STRUCTURE TO BE PRESSURE-TREATED WITH PRESERVATIVE

AEP TEXAS, I&M, KYPCo, APCo, AEP OHIO

SERVICE DROPS UP TO 50 FEET ONE 4X4" (NOM.) OR TWO 2X4" (NOM.) MINIMUM TIMBER

SERVICE DROPS UP TO 100 FEET TWO 2X6" (NOM.) TIMBERS OR PINE POLE WITH 5" MINIMUM DIAMETER ROUND TOP

PSO AND SWEPCo (INCLUDING SWEPCo TEXAS)

PINE POLE WITH 5" MINIMUM DIAMETER ROUND TOP

- CUSTOMER FUSE BOX AND SWITCH MAY REQUIRE CURRENT LIMITING FUSES TO COMPLY WITH LOCAL CODES.

- BURIAL DEPTH IS THE DISTANCE BETWEEN FINAL GRADE AND THE TOP OF THE BURIED CABLE OR CONDUIT. THE POWER COMPANY (AEP) SHALL SPECIFY THE REQUIRED BURIAL DEPTH PER OPERATING COMPANY AS PRESCRIBED IN THE PROCEEDING LIST:

COMPANY	BURIAL DEPTH
APCO	= REQUIRES A BURIAL DEPTH OF 30"
KYPCO	= REQUIRES A BURIAL DEPTH OF 30"
I&M	= REQUIRES A BURIAL DEPTH OF 30"
OHIO	= REQUIRES A BURIAL DEPTH OF 30"
TEXAS	= REQUIRES A BURIAL DEPTH OF 36"
PSO	= REQUIRES A BURIAL DEPTH OF 36"
SWEPCO	= REQUIRES A BURIAL DEPTH OF 36"

AND/OR CONFORM TO ANY OR ALL AUTHORITY HAVING JURISDICTION. THE POWER COMPANY (AEP) HAS PRESCRIBED THE BURIAL DEPTH SHALL NOT BE LESS THAN STATED DEPTH ON THE PRECEDING LIST UNLESS IMPOSSIBLE TO BE ACHIEVED OR IS SUPERSEDED BY LOCAL AUTHORITY HAVING JURISDICTION. IF THE DEPTH IS IMPOSSIBLE TO ACHIEVED AEP'S VERIFICATION WILL BE NEEDED. HOWEVER, BURIAL DEPTH NOT TO BE LESS THAN WHAT IS STATED IN THE NATIONAL ELECTRICAL CODE'S ARTICLES AND TABLES: ARTICLE 300: 300.3(B) (1), 300.3 (C) (1) (2), TABLE 300.5, AND TABLE 300.50

- CUSTOMER GROUNDING SHALL BE IN ACCORDANCE WITH NATIONAL ELECTRICAL CODE. IN ARKANSAS, OKLAHOMA, LOUISIANA, AND TEXAS, THE GROUNDING WIRE SHALL BE CONNECTED TO THE UTILITIES NEUTRAL AT THIS POINT IN THE METER SOCKET. THE CUSTOMER SHALL HAVE A MINIMUM OF 2 DRIVEN GROUND RODS AT LEAST 6 FEET APART OR MUST MEET NEC GROUNDING REQUIREMENTS.

- ANTI-OXIDANT COMPOUNDS SHALL NOT BE USED ON METER SOCKET BLADES OR METER BASE JAWS.

ANTI-OXIDANT COMPOUNDS CAN BE USED ON ALUMINUM CONDUCTORS AND METER BASE TERMINAL PER LOCAL AHJ (AUTHORITY HAVING JURISDICTION).

FOR FURTHER INFORMATION ON UTILITY REQUIREMENTS PLEASE CONTACT YOUR LOCAL AEP OPERATING COMPANY.

SEE GENERAL CONDITION NOTES FOR COMPANY AND CUSTOMER RESPONSIBILITIES

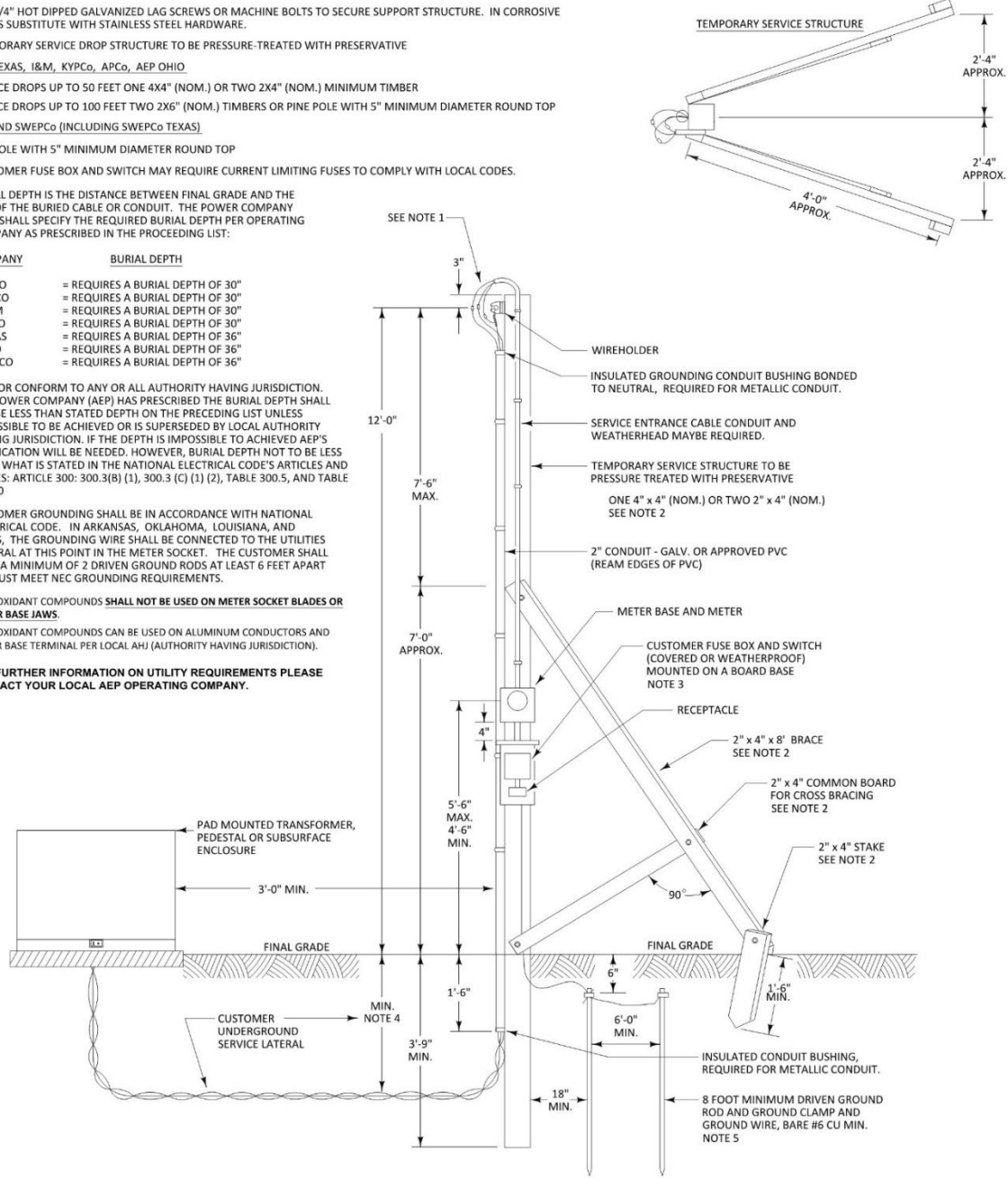

ALTERNATE TEMPORARY SERVICE INSTALLATION  
FROM EXISTING URD SECONDARY

AMERICAN ELECTRIC POWER COMPANY  
METER STANDARDS

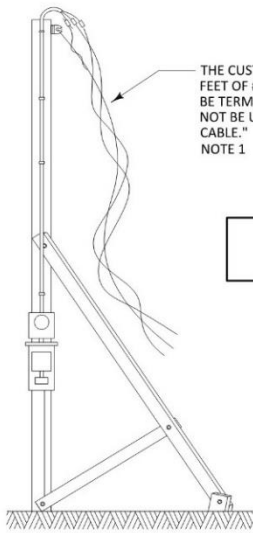

SEE GENERAL CONDITION NOTES FOR COMPANY AND CUSTOMER RESPONSIBILITIES

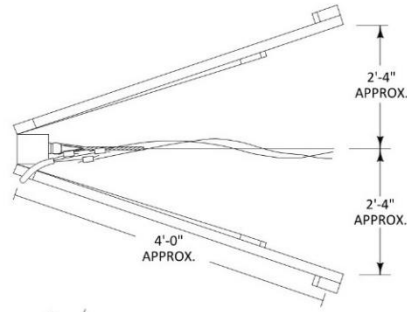

GENERAL CONDITION NOTES:

THE COMPANY WILL BE RESPONSIBLE FOR:

- (a) PROVIDING AND INSTALLING OVERHEAD SERVICE DROP (NO.2 OR NO.4 TRIPLEX SERVICE DROP).
- (b) PROVIDING THE METER BASE TO THE CUSTOMER WHERE REQUIRED.
- (c) INSTALLING AND REMOVING THE METER.

THE CUSTOMER WILL BE RESPONSIBLE FOR:

- (a) PROVIDING AND INSTALLING THE COMPLETED TEMPORARY STRUCTURE TO WHICH SERVICE DROP WILL BE ATTACHED. INSTALLATION MUST MEET THE COMPANY'S REQUIREMENTS TO BE CONNECTED. SERVICE ENTRANCE CONDUCTORS SHALL PROJECT FROM WEATHERHEAD A MINIMUM OF 18 INCHES.
- (b) A TOOL SHED (IF AVAILABLE) OR OTHER TYPE OF FIXED SUPPORT MAY BE USED AS A TEMPORARY SERVICE DROP ATTACHMENT IF SUCH SUPPORT PROVIDES EQUAL STRENGTH AND PROPER CLEARANCES.

GENERAL CONSTRUCTION NOTES:

1. IN KENTUCKY, TENNESSEE, VIRGINIA, AND WEST VIRGINIA, THE ADDITIONAL TRIPLEX CABLE IS NOT REQUIRED IF THE TEMPORARY SERVICE DROP STRUCTURE IS TRUCK ACCESSIBLE.
2. TEMPORARY SERVICE DROPS NOT TO EXCEED 100 FEET.
3. THE SERVICE ATTACHMENT SHALL BE INSTALLED AT A HEIGHT THAT MAINTAINS PROPER CLEARANCES FOR SERVICE DROP CONDUCTORS. REFER TO FIGURE M.S.\_F005.
4. ARKANSAS, OKLAHOMA, LOUISIANA, AND TEXAS: METER SOCKET USED ON COMMERCIAL CUSTOMER SHALL HAVE A LEVER-OPERATED BYPASS FOR THREE-PHASE AND FOR SINGLE-PHASE.
5. CUSTOMER FUSE BOX AND SWITCH MAY REQUIRE CURRENT-LIMITING FUSES TO COMPLY WITH LOCAL CODES.
6. USE 3/4" x 4" HOT-DIPPED GALVANIZED LAG SCREWS OR MACHINE BOLTS TO SECURE SUPPORT STRUCTURE. IN CORROSIVE AREAS, SUBSTITUTE WITH STAINLESS STEEL HARDWARE.
7. A 2" x 4" STAKE IS RECOMMENDED BUT DEPENDENT ON SOIL CONDITIONS. OTHER MATERIAL SUCH AS CONCRETE FORM STAKES MAY BE USED TO SECURE THE SUPPORT STRUCTURE.
8. CUSTOMER GROUNDING SHALL BE IN ACCORDANCE WITH NATIONAL ELECTRICAL CODE. IN ARKANSAS, OKLAHOMA, LOUISIANA, AND TEXAS, THE GROUNDING WIRE SHALL BE CONNECTED TO THE UTILITIES' NEUTRAL AT THIS POINT IN THE METER SOCKET. THE CUSTOMER SHALL HAVE A MINIMUM OF 2 DRIVEN GROUND RODS AT LEAST 6 FEET APART, OR MUST MEET NEC GROUNDING REQUIREMENTS.
9. ANTI-OXIDANT COMPOUNDS SHALL NOT BE USED ON METER SOCKET BLADES OR METER BASE JAWS.  
*ANTI-OXIDANT COMPOUNDS CAN BE USED ON ALUMINUM CONDUCTORS AND METER BASE TERMINAL PER THE AHJ OF YOUR AREA.*

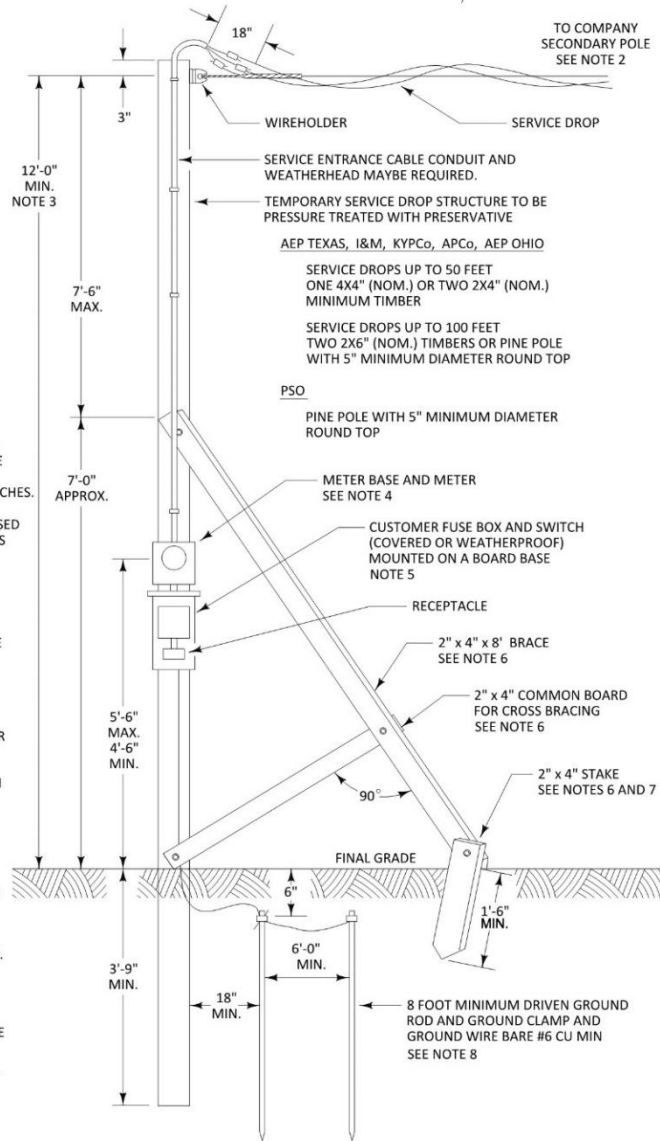

TEMPORARY SERVICE INSTALLATION  
FROM EXISTING OVERHEAD SECONDARY

# M.S.\_F004 – SINGLE MOBILE HOME OVERHEAD SERVICE

**TABLE: I**  
POLE DIMENSIONS AND SETTING DEPTH

LENGTH OF POLE (FEET)	MINIMUM SETTING DEPTH (FEET)	MINIMUM POLE CIRCUMFERENCE (INCHES)	MINIMUM POLE DIAMETER (INCHES)
		AT TOP 15"	AT TOP 4 3/4"
		AT GROUND LINE	AT GROUND LINE
18'	4'-0"	17 1/2"	5 1/2"
20'	4'-6"	18 1/2"	6"
22'	4'-6"	19 1/2"	6 1/4"
25'	5'-0"	20"	6 1/2"

**GENERAL CONDITION NOTES:**

THE COMPANY WILL BE RESPONSIBLE FOR:

- (a) SPECIFYING THE SERVICE POLE LOCATION, AND SERVICE DROP ATTACHMENT HEIGHT. NOTE: (NEC) RECOMMENDS THAT THE SERVICE EQUIPMENT BE "IN SIGHT FROM" AND WITHIN 30' OF THE MOBILE HOME.
- (b) PROVIDING AND INSTALLING THE OVERHEAD SERVICE DROP.
- (c) PROVIDING THE METER BASE TO CUSTOMER WHERE REQUIRED.
- (d) INSTALLING AND REMOVING THE METER.

THE CUSTOMER WILL BE RESPONSIBLE FOR:

- (a) PROVIDING AN ADEQUATE GROUND TO THE FRAME OF THE SERVICE EQUIPMENT DISCONNECT DEVICE. GROUND IN ACCORDANCE WITH NEC ARTICLE 250 AND LOCAL CODES. GROUNDING IS TYPICALLY PROVIDED BY 8'-0" DRIVEN GROUND ROD(S) OR BY A METALLIC WATER PIPE BONDED TO 8'-0" DRIVEN GROUND ROD(S). IF A METALLIC WATER PIPING SYSTEM IS PRESENT, IT MUST BE BONDED TO THE 8'-0" DRIVEN GROUND ROD(S).
- (b) PROVIDING AND SECURELY INSTALLING THE SERVICE ENTRANCE CABLE, RIGID CONDUIT AND WEATHER HEAD AS REQUIRED BY LOCAL CODES. NON-METALLIC CONDUIT PERMITTED IF INSTALLED IN ACCORDANCE WITH NEC AND APPROVED BY LOCAL INSPECTION AUTHORITY. SERVICE ENTRANCE CONDUCTORS SHALL PROJECT FROM WEATHERHEAD A MINIMUM OF 18 INCHES. ONLY POWER SERVICE CONDUCTORS ARE ALLOWED TO CONTACT THE SERVICE MAST, NEC (230-28).
- (c) PROVIDING AND INSTALLING SERVICE EQUIPMENT DISCONNECT DEVICE. TYPICAL CONFIGURATIONS SHOWN (OTHER CONFIGURATIONS AVAILABLE). THE DISCONNECT DEVICE IS TO HAVE OVERCURRENT PROTECTION AND TO BE IN A WEATHERPROOF ENCLOSURE. CUSTOMER TO SELECT U.L. LISTED EQUIPMENT BEST SUITED TO THEIR NEEDS.
- (d) SECURELY MOUNT THE METER BASE IN A PLUMB POSITION. METER MUST FACE STREET OR ACCESS WALKWAY.
- (e) PROVIDING AND SECURELY INSTALLING THE SERVICE POLE AND GUYING (IF NEEDED). SERVICE POLE IS TO BE TREATED WITH AN EPA REGISTERED PRESERVATIVE. POLE SETTING DEPTH TO BE IN ACCORDANCE WITH TABLE I.

**GENERAL CONSTRUCTION NOTES:**

1. THIS INSTALLATION IS FOR A SINGLE MOBILE HOME ONLY. FOR MOBILE HOMES IN PARKS, REFER TO FIGURE 9.
2. THE SERVICE ATTACHMENT SHALL BE INSTALLED AT A HEIGHT THAT MAINTAINS PROPER CLEARANCES FOR SERVICE DROP CONDUCTORS. REFER TO FIGURE 5.
3. A GROUNDING AS WELL AS A GROUNDED CONDUCTOR MUST EXTEND BETWEEN THE MOBILE HOME AND ITS ADJACENT SERVICE EQUIPMENT. NEITHER THE FRAME OF THE MOBILE HOME NOR THE FRAME OF ANY DISTRIBUTION PANEL OR APPLIANCE MAY BE CONNECTED TO THE NEUTRAL (GROUNDED) CONDUCTOR IN THE MOBILE HOME. THE GROUNDING AND GROUNDED CONDUCTOR ARE BONDED TOGETHER ONLY ON THE SUPPLY SIDE OF THE SERVICE DISCONNECT DEVICE. REFER TO ARTICLE 550.16 OF NEC GROUNDING.
4. BURIAL DEPTH IS THE DISTANCE BETWEEN FINAL GRADE AND THE TOP OF THE BURIED CABLE OR CONDUIT. THE POWER COMPANY (AEP) SHALL SPECIFY THE REQUIRED BURIAL DEPTH PER OPERATING COMPANY AS PRESCRIBED IN THE PRECEDING LIST:

COMPANY	BURIAL DEPTH
APCO	= REQUIRES A BURIAL DEPTH OF 30"
KYPCO	= REQUIRES A BURIAL DEPTH OF 30"
I&M	= REQUIRES A BURIAL DEPTH OF 30"
OHIO	= REQUIRES A BURIAL DEPTH OF 30"
TEXAS	= REQUIRES A BURIAL DEPTH OF 36"
PSO	= REQUIRES A BURIAL DEPTH OF 36"
SWEPKO	= REQUIRES A BURIAL DEPTH OF 36"

AND/OR CONFORM TO ANY OR ALL AUTHORITY HAVING JURISDICTION. THE POWER COMPANY (AEP) HAS PRESCRIBED THE BURIAL DEPTH SHALL NOT BE LESS THAN STATED DEPTH ON THE PRECEDING LIST UNLESS IMPOSSIBLE TO BE ACHIEVED OR IS SUPERSEDED BY LOCAL AUTHORITY HAVING JURISDICTION. IF THE DEPTH IS IMPOSSIBLE TO ACHIEVED AEP'S VERIFICATION WILL BE NEEDED. HOWEVER, BURIAL DEPTH NOT TO BE LESS THAN WHAT IS STATED IN THE NATIONAL ELECTRICAL CODE'S ARTICLES AND TABLE 300.5.

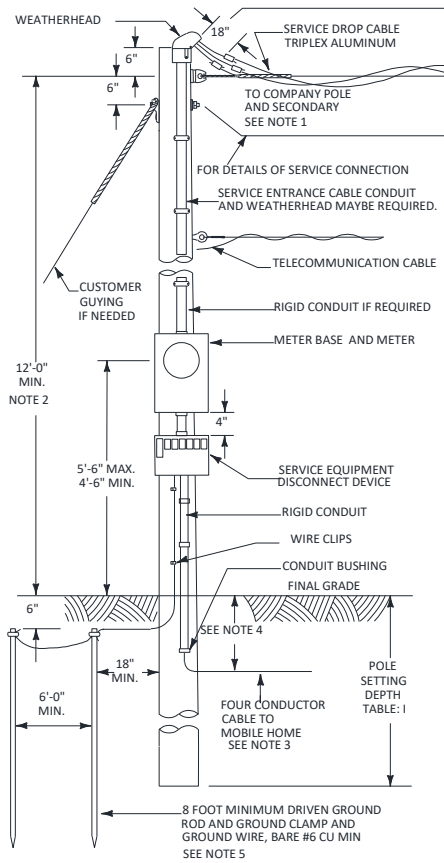

**GENERAL CONSTRUCTION NOTE CONTINUED:**

5. CUSTOMER GROUNDING SHALL BE IN ACCORDANCE WITH NATIONAL ELECTRICAL CODE. IN ARKANSAS, OKLAHOMA, LOUISIANA, AND TEXAS, THE GROUNDING WIRE SHALL BE CONNECTED TO THE UTILITIES NEUTRAL AT THIS POINT IN THE METER SOCKET. THE CUSTOMER SHALL HAVE A MINIMUM OF 2 DRIVEN GROUND RODS AT LEAST 6 FEET APART OR MUST MEET NEC GROUNDING REQUIREMENTS.
  6. AEP REQUIRES THAT SURGE PROTECTION BE EMPLOYED AS PER THE NEC ARTICLE 230.67 (BASE ON THE 2020). SURGE PROTECTION IN ALL NEW SERVICE AND SERVICE UPDATES
  7. ANTI-OXIDANT COMPOUNDS SHALL NOT BE USED ON METER SOCKET BLADES OR METER BASE JAWS. ANTI-OXIDANT COMPOUNDS CAN BE USED ON ALUMINUM CONDUCTORS AND METER BASE TERMINAL PER THE AHJ OF YOUR AREA.
- FOR FURTHER INFORMATION ON UTILITY REQUIREMENTS PLEASE CONTACT YOUR LOCAL AEP OPERATING COMPANY.

SEE GENERAL CONDITION NOTES FOR POWER COMPANY AND CUSTOMER RESPONSIBILITIES

## SINGLE MOBILE HOME OVERHEAD SERVICE

AMERICAN ELECTRIC POWER COMPANY  
METER STANDARDS

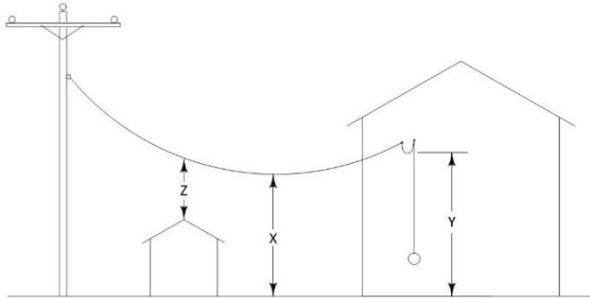

X IN-SPAN GROUND CLEARANCE  
Y DRIP LOOP GROUND CLEARANCE  
Z ROOF OR BALCONY CLEARANCE

NOTES:

- ALL CLEARANCES LISTED ARE SPECIFIED BY THE NESC. THESE ARE MINIMUM CLEARANCES WHICH MUST BE MET FOR THE SAG CONDITION WHICH CAN OCCUR EITHER AT: MAXIMUM OPERATING CONDUCTOR TEMPERATURE OR MAXIMUM LOADING AT 32 F, NESC ICE, FINAL SAG.

AN INCREASE IN DESIGN CLEARANCE AT TIME OF INSTALLATION IS RECOGNIZED AND ACCEPTABLE TO ACCOUNT FOR FUTURE RESURFACING OR GRADE CHANGES. A 12 INCH INCREASE IS TYPICAL IN LIEU OF ANY SPECIFIC INFORMATION. IT IS RECOMMENDED THAT THIS FACTOR SHOULD BE CONSIDERED AND, AS APPROPRIATE, INCLUDED WHEN PLANNING SERVICE INSTALLATIONS.

A POINT OF CLARIFICATION IS NECESSARY REGARDING WHAT CAN APPEAR TO BE A 2 FOOT INCONSISTENCY BETWEEN THE NESC AND THE NEC FOR CLEARANCES OVER "ROADS, STREETS, DRIVEWAYS, PARKING LOTS, ALLEYS AND OTHER AREAS SUBJECT TO TRUCK TRAFFIC" (NESC - 16 FEET VS. NEC - 18 FEET). NEC CLEARANCES ARE SPECIFIED (WITH LESS SAG) AT A CONDUCTOR TEMPERATURE OF 60°F, NO WIND, WITH FINAL UNLOADED SAG IN THE CONDUCTOR. THE 2 FOOT DIFFERENCE IS PARTIALLY ATTRIBUTED TO COMPARATIVELY LARGER SAG BY NESC SPECIFICATIONS. ADDITIONAL ALLOWANCES MADE FOR RESURFACING, ETC. IN APPLICATION OF THE NESC RULE WILL ACCOUNT FOR THE REST OF THE 2 FOOT DIFFERENCE. A SERVICE INSTALLED TO EITHER SPECIFICATION WOULD BE VERY SIMILAR WHEN ANALYZED BY THE OTHER. THEREFORE, THERE IS NO PRACTICAL INCONSISTENCY BETWEEN THE TWO CODES IN THIS SITUATION.

- IN ADDITION TO PROPER DESIGN FOR GROUND/SURFACE CLEARANCES, BE CAREFUL TO PROVIDE CLEARANCES FROM BUILDING OPENINGS, WINDOWS, DOORS ETC. (TYPICALLY 3'-0"). PROVIDE A MINIMUM CLEARANCE OF THREE (3) INCHES FROM DOWNSPOUTS AND EAVES FOR SERVICE CONDUCTORS 0 TO 750 VOLT. FOR CONDUCTORS MEETING NESC RULE 230C1, 230C2 OR 230C3 THIS CLEARANCE MAY BE REDUCED TO ONE (1) INCH. ROUTE SERVICES SO THAT RAISED PATIO/DECK AREAS CAN BE AVOIDED IF POSSIBLE. AS AN ALTERNATIVE, CONSIDER PROVIDING ADDITIONAL CLEARANCE WHEN FEASIBLE.
- TRUCKS ARE DEFINED AS ANY VEHICLE EXCEEDING 8 FEET IN HEIGHT. AREAS NOT SUBJECT TO TRUCK TRAFFIC ARE AREAS WHERE TRUCK TRAFFIC IS NEITHER NORMALLY ENCOUNTERED NOR REASONABLY ANTICIPATED.
- FOR RESIDENTIAL DRIVEWAYS ONLY, WHEN A BUILDING DOES NOT HAVE SUFFICIENT HEIGHT TO ALLOW A SERVICE ATTACHMENT LOCATION WHICH WILL PROVIDE 15 FEET OF CLEARANCE, THE CLEARANCES MAY BE REDUCED TO:

SERVICES 277 VLG: IN-SPAN GROUND CLEARANCE - 12.5 FEET  
DRIP LOOP GROUND CLEARANCE - 10.5 FEET

SERVICES 120 VLG: IN-SPAN GROUND CLEARANCE - 12.0 FEET  
DRIP LOOP GROUND CLEARANCE - 10.0 FEET

SERVICE DROP CABLE CLEARANCES

NATURE OF SURFACE UNDERNEATH SERVICE DROP CABLE	VERTICAL CLEARANCE ABOVE SURFACE FOR SERVICE DROP CABLE (FEET) SEE NOTES 1 AND 2
TRACK RAILS OF RAILROADS	24.0
ROADS, STREETS, DRIVEWAYS, PARKING LOTS, ALLEYS AND OTHER AREAS SUBJECT TO TRUCK TRAFFIC SEE NOTE 3	16.0
DRIVEWAYS, PARKING LOTS, AND ALLEYS	16.0 SEE NOTE 4
SPACES AND WAYS SUBJECT TO PEDESTRIANS OR RESTRICTED TRAFFIC ONLY SEE NOTE 5	12.0 SEE NOTE 6
ROOFS OR BALCONIES	11.0 SEE NOTE 7
SWIMMING POOLS	22.5 SEE NOTE 8

- SPACES AND WAYS SUBJECT TO PEDESTRIAN OR RESTRICTED TRAFFIC ONLY ARE THOSE AREAS WHERE RIDERS ON HORSEBACK, VEHICLES OR OTHER MOBILE UNITS EXCEEDING 8 FEET IN HEIGHT, ARE PROHIBITED BY REGULATION OR PERMANENT TERRAIN CONFIGURATIONS OR ARE OTHERWISE NOT NORMALLY ENCOUNTERED NOR REASONABLY ANTICIPATED.

- FOR RESIDENTIAL DRIVEWAYS ONLY, WHEN A BUILDING DOES NOT HAVE SUFFICIENT HEIGHT TO ALLOW A SERVICE ATTACHMENT LOCATION WHICH WILL PROVIDE 12 FEET OF CLEARANCE, THE CLEARANCE MAY BE REDUCED TO:

SERVICES 277 VLG:

IN-SPAN GROUND CLEARANCE - 10.5 FEET  
DRIP LOOP GROUND CLEARANCE - AS PER NEC 230-54(F)(G)

SERVICES 120 VLG:

IN-SPAN GROUND CLEARANCE - 10.0 FEET  
DRIP LOOP GROUND CLEARANCE - AS PER NEC 230-54(F)(G)

- WHERE ROOFS OR BALCONIES ARE NOT READILY ACCESSIBLE AND WHERE VOLTAGE BETWEEN SERVICE CONDUCTORS DOES NOT EXCEED 300 VOLTS OR WHERE CABLES MEETING NESC RULE 230C2 OR 230C3 AND VOLTAGE DOES NOT EXCEED 750 VOLTS, CLEARANCE MAY BE REDUCED TO 3.5 FEET.

- CLEARANCE IN ANY DIRECTION FROM THE POOL WATER LEVEL, EDGE OF POOL, BASE OF DIVING PLATFORM OR ANCHORED RAFT. CLEARANCE IN ANY DIRECTION TO A DIVING PLATFORM IS 14 FEET.

**FOR FURTHER INFORMATION ON UTILITY REQUIREMENTS PLEASE CONTACT YOUR LOCAL AEP OPERATING COMPANY.**

SERVICE DROP CABLE CLEARANCES FOR DUPLEX,  
TRIPLEX AND QUADRUPLX CONDUCTORS

AMERICAN ELECTRIC POWER COMPANY  
METER STANDARDS

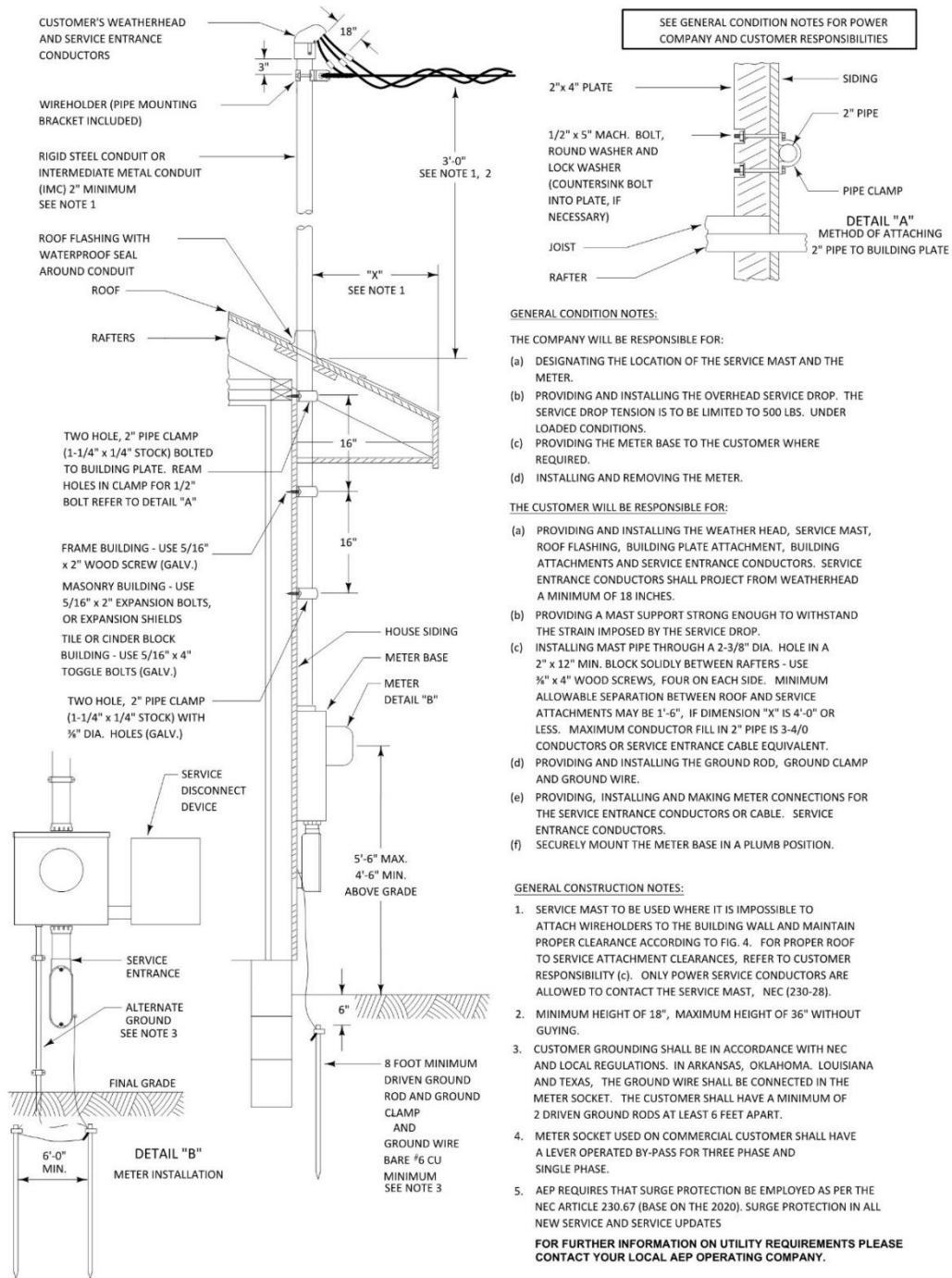

- GENERAL CONDITION NOTES:**
- THE COMPANY WILL BE RESPONSIBLE FOR:
- (a) DESIGNATING THE LOCATION OF THE SERVICE MAST AND THE METER.
  - (b) PROVIDING AND INSTALLING THE OVERHEAD SERVICE DROP. THE SERVICE DROP TENSION IS TO BE LIMITED TO 500 LBS. UNDER LOADED CONDITIONS.
  - (c) PROVIDING THE METER BASE TO THE CUSTOMER WHERE REQUIRED.
  - (d) INSTALLING AND REMOVING THE METER.
- THE CUSTOMER WILL BE RESPONSIBLE FOR:
- (a) PROVIDING AND INSTALLING THE WEATHER HEAD, SERVICE MAST, ROOF FLASHING, BUILDING PLATE ATTACHMENT, BUILDING ATTACHMENTS AND SERVICE ENTRANCE CONDUCTORS. SERVICE ENTRANCE CONDUCTORS SHALL PROJECT FROM WEATHERHEAD A MINIMUM OF 18 INCHES.
  - (b) PROVIDING A MAST SUPPORT STRONG ENOUGH TO WITHSTAND THE STRAIN IMPOSED BY THE SERVICE DROP.
  - (c) INSTALLING MAST PIPE THROUGH A 2-3/8" DIA. HOLE IN A 2" x 12" MIN. BLOCK SOLIDLY BETWEEN RAFTERS - USE 3/4" x 4" WOOD SCREWS, FOUR ON EACH SIDE. MINIMUM ALLOWABLE SEPARATION BETWEEN ROOF AND SERVICE ATTACHMENTS MAY BE 1'-6", IF DIMENSION "X" IS 4'-0" OR LESS. MAXIMUM CONDUCTOR FILL IN 2" PIPE IS 3-4/0 CONDUCTORS OR SERVICE ENTRANCE CABLE EQUIVALENT.
  - (d) PROVIDING AND INSTALLING THE GROUND ROD, GROUND CLAMP AND GROUND WIRE.
  - (e) PROVIDING, INSTALLING AND MAKING METER CONNECTIONS FOR THE SERVICE ENTRANCE CONDUCTORS OR CABLE. SERVICE ENTRANCE CONDUCTORS.
  - (f) SECURELY MOUNT THE METER BASE IN A PLUMB POSITION.

- GENERAL CONSTRUCTION NOTES:**
1. SERVICE MAST TO BE USED WHERE IT IS IMPOSSIBLE TO ATTACH WIREHOLDERS TO THE BUILDING WALL AND MAINTAIN PROPER CLEARANCE ACCORDING TO FIG. 4. FOR PROPER ROOF TO SERVICE ATTACHMENT CLEARANCES, REFER TO CUSTOMER RESPONSIBILITY (c). ONLY POWER SERVICE CONDUCTORS ARE ALLOWED TO CONTACT THE SERVICE MAST, NEC (230-28).
  2. MINIMUM HEIGHT OF 18", MAXIMUM HEIGHT OF 36" WITHOUT GUYING.
  3. CUSTOMER GROUNDING SHALL BE IN ACCORDANCE WITH NEC AND LOCAL REGULATIONS. IN ARKANSAS, OKLAHOMA, LOUISIANA AND TEXAS, THE GROUND WIRE SHALL BE CONNECTED IN THE METER SOCKET. THE CUSTOMER SHALL HAVE A MINIMUM OF 2 DRIVEN GROUND RODS AT LEAST 6 FEET APART.
  4. METER SOCKET USED ON COMMERCIAL CUSTOMER SHALL HAVE A LEVER OPERATED BY-PASS FOR THREE PHASE AND SINGLE PHASE.
  5. AEP REQUIRES THAT SURGE PROTECTION BE EMPLOYED AS PER THE NEC ARTICLE 230.67 (BASE ON THE 2020). SURGE PROTECTION IN ALL NEW SERVICE AND SERVICE UPDATES

FOR FURTHER INFORMATION ON UTILITY REQUIREMENTS PLEASE CONTACT YOUR LOCAL AEP OPERATING COMPANY.

SERVICE ATTACHMENT TO MAST  
OF LOW PROFILE OR OTHER BUILDING

AMERICAN ELECTRIC POWER COMPANY  
METER STANDARDS

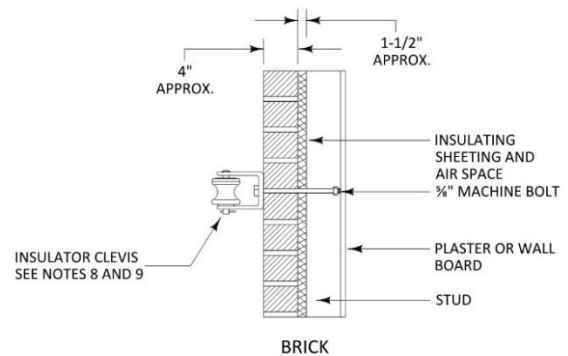
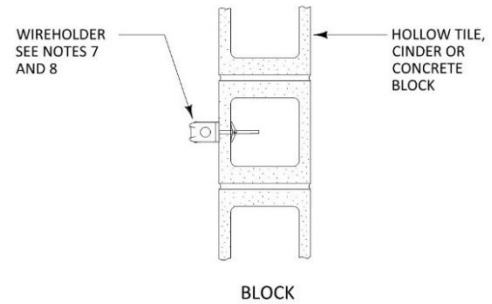
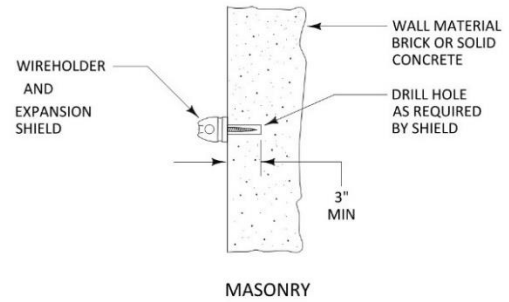
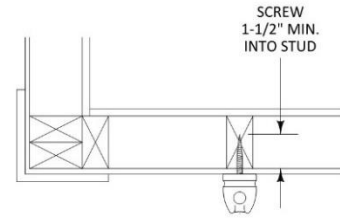
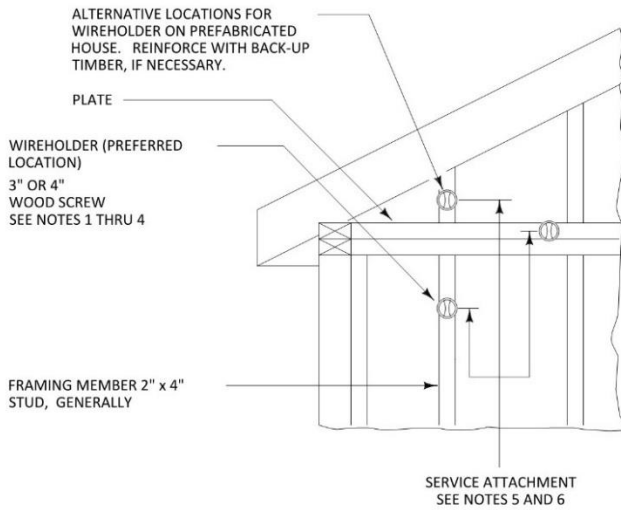

NOTES:

1. SELECTION OF A 3 OR 4 INCH SCREW LENGTH IS DEPENDENT ON THE THICKNESS OF MATERIAL (FACING, INSULATION - ETC.) WHICH MUST BE PENETRATED BEFORE A SOLID FRAMING MEMBER IS ENCOUNTERED.
2. DRILL A 7/32" DIAMETER HOLE INTO THE WALL STUD BEFORE INSTALLING WIREHOLDERS (TO AVOID SPLITTING THE WOOD OR BREAKING THE WIREHOLDER). WIREHOLDER SCREW MUST BE INSTALLED AS FAR AS POSSIBLE SO THAT WIREHOLDER IS TIGHT AND FLUSH WITH OUTSIDE FRAME SURFACE. AT LEAST 1-1/2" OF SCREW MUST PENETRATE THE STUD.
3. FOR PREFABRICATED HOUSES - WHERE THE STUD IS GENERALLY 2" X 2", CUT THE WIREHOLDER SCREW TO THE REQUIRED LENGTH WITH BOLT CUTTERS IF GROUND CLEARANCES PERMIT SERVICE DROP TO BE ATTACHED BELOW CEILING LINE. OTHERWISE, USE ALTERNATIVE WIREHOLDER LOCATIONS SHOWN OR USE A SERVICE MAST, REFER TO FIGURE M.S.\_F006.
4. STRUCTURE LOADING AT WIREHOLDER:
  - (a) FOR #4, #2 AWG AND 1/0 SERVICE DROP CABLE - STRUCTURE TO WITHSTAND A MINIMUM PULL OF 1000 LBS. PER WIREHOLDER.
  - (b) FOR 4/0 AWG SERVICE DROP CABLE - STRUCTURE TO WITHSTAND A MINIMUM PULL OF 1500 LBS. PER WIREHOLDER.
5. THE SERVICE ATTACHMENT SHALL BE INSTALLED AT A HEIGHT THAT MAINTAINS REQUIRED CLEARANCES FOR SERVICE DROP CONDUCTORS. FOR CLEARANCES, REFER TO FIGURE M.S.\_F005.
6. SERVICE MAST TO BE USED WHERE IT IS IMPOSSIBLE TO ATTACH WIREHOLDER TO BUILDING WALL AND MAINTAIN PROPER CLEARANCES TO GROUND. A SERVICE MAST FOR A RESIDENCE IS REQUIRED TO PROVIDE THE REDUCED CLEARANCES OVER RESIDENTIAL DRIVEWAYS AS SHOWN IN FIGURE M.S.\_F005.
7. COAT ALL METAL PARTS OF THESE SERVICE DROP ATTACHMENTS WITH CORROSION-INHIBITING GREASE (WITHOUT METALLIC PARTICLES) BEFORE INSTALLING THEM IN MASONRY OR CINDER BLOCKS.
8. NEW CONSTRUCTION - FURNISH CUSTOMER OR CONTRACTOR WITH PROPER WIREHOLDER OR INSULATOR CLEVIS SO THAT SERVICE ATTACHMENT CAN BE INSTALLED AT A SUITABLE LOCATION (DESIGNATED BY THE POWER COMPANY) BY THE CONTRACTOR DURING CONSTRUCTION OF THE BUILDING.
9. FOR BRICK BUILDINGS OF RELATIVELY SOFT BRICK, INSTALL THE WIREHOLDER SCREW IN THE MORTAR BETWEEN THE BRICKS.

FOR FURTHER INFORMATION ON UTILITY REQUIREMENTS PLEASE CONTACT YOUR LOCAL AEP OPERATING COMPANY.

SERVICE DROP ATTACHMENTS AT BUILDING

AMERICAN ELECTRIC POWER COMPANY  
METER STANDARDS

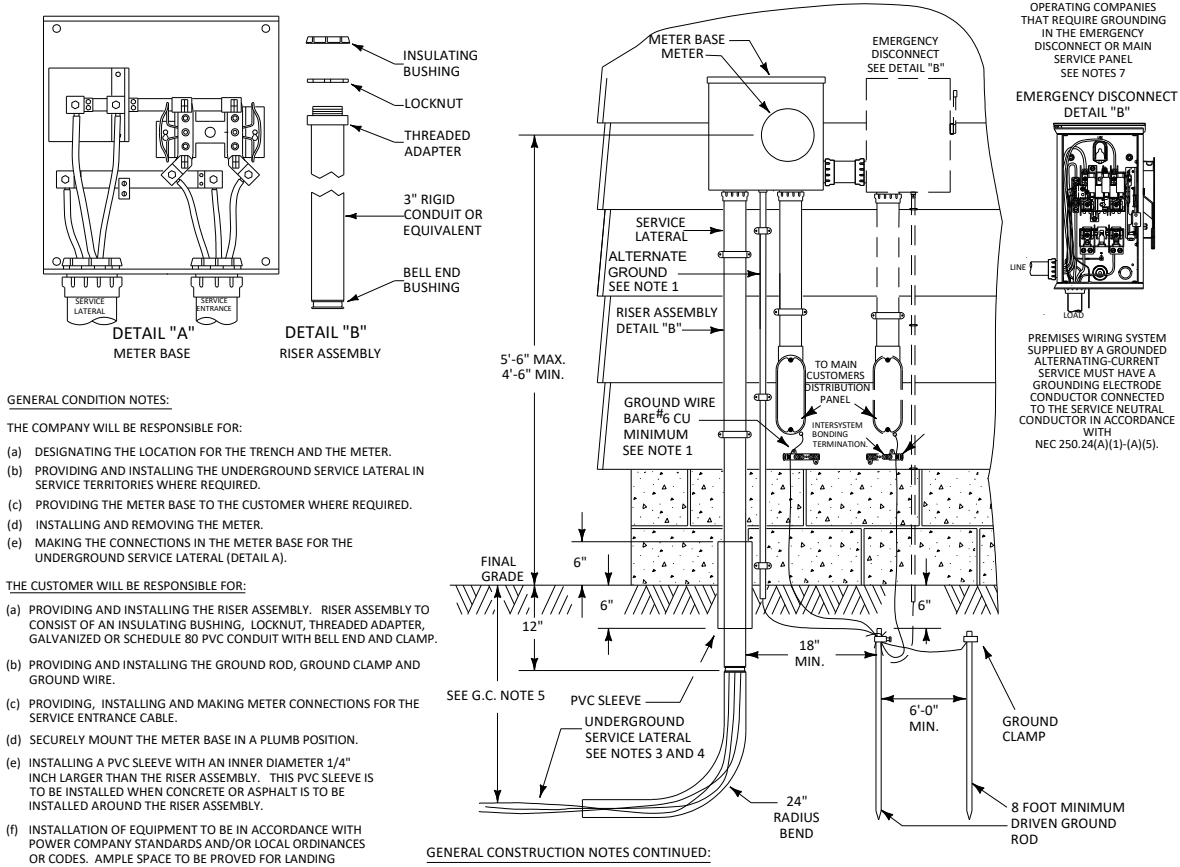

GENERAL CONDITION NOTES:

THE COMPANY WILL BE RESPONSIBLE FOR:

- DESIGNATING THE LOCATION FOR THE TRENCH AND THE METER.
- PROVIDING AND INSTALLING THE UNDERGROUND SERVICE LATERAL IN SERVICE TERRITORIES WHERE REQUIRED.
- PROVIDING THE METER BASE TO THE CUSTOMER WHERE REQUIRED.
- INSTALLING AND REMOVING THE METER.
- MAKING THE CONNECTIONS IN THE METER BASE FOR THE UNDERGROUND SERVICE LATERAL (DETAIL A).

THE CUSTOMER WILL BE RESPONSIBLE FOR:

- PROVIDING AND INSTALLING THE RISER ASSEMBLY. RISER ASSEMBLY TO CONSIST OF AN INSULATING BUSHING, LOCKNUT, THREADED ADAPTER, GALVANIZED OR SCHEDULE 80 PVC CONDUIT WITH BELL END AND CLAMP.
- PROVIDING AND INSTALLING THE GROUND ROD, GROUND CLAMP AND GROUND WIRE.
- PROVIDING, INSTALLING AND MAKING METER CONNECTIONS FOR THE SERVICE ENTRANCE CABLE.
- SECURELY MOUNT THE METER BASE IN A PLUMB POSITION.
- INSTALLING A PVC SLEEVE WITH AN INNER DIAMETER 1/4" INCH LARGER THAN THE RISER ASSEMBLY. THIS PVC SLEEVE IS TO BE INSTALLED WHEN CONCRETE OR ASPHALT IS TO BE INSTALLED AROUND THE RISER ASSEMBLY.
- INSTALLATION OF EQUIPMENT TO BE IN ACCORDANCE WITH POWER COMPANY STANDARDS AND/OR LOCAL ORDINANCES OR CODES. AMPLE SPACE TO BE PROVIDED FOR LANDING CONDUCTORS.

GENERAL CONSTRUCTION NOTES:

- CUSTOMER GROUNDING SHALL BE IN ACCORDANCE WITH NEC AND LOCAL REGULATIONS. IN ARKANSAS, OKLAHOMA, LOUISIANA, AND TEXAS, THE GROUND WIRE SHALL BE CONNECTED IN THE METER SOCKET IN CONDUIT WHERE REQUIRED. THE CUSTOMER SHALL HAVE A MINIMUM OF 2 DRIVEN GROUND RODS AT LEAST 6 FEET APART.
- METER SOCKET USED ON COMMERCIAL CUSTOMER SHALL HAVE A LEVER OPERATED JAW RELEASE BY-PASS FOR THREE PHASE AND SINGLE PHASE.
- IF THE CUSTOMER DOES THE TRENCHING, THE TRENCH IS TO EXTEND NO CLOSER TO THE POWER COMPANY'S TRANSFORMER OR PEDESTAL THAN A DISTANCE SPECIFIED BY THE POWER COMPANY. CUSTOMER TO DETERMINE LOCATION OF ALL UTILITIES BEFORE TRENCHING.
- ADDITIONAL PVC CONDUIT AND A 24 INCH BEND MAY BE INSTALLED IN ORDER TO EXTEND CONDUIT BEYOND ANY GROUND LEVEL OBSTRUCTION (PATIO, DECK, DRIVEWAY, WALKWAY, ETC.). IF ADDITIONAL PVC CONDUIT IS REQUIRED TO CLEAR OBSTRUCTIONS, REFER TO POWER COMPANY FOR APPROVED PVC USAGE.
- BURIAL DEPTH IS THE DISTANCE BETWEEN FINAL GRADE AND THE TOP OF THE BURIED CABLE OR CONDUIT. THE POWER COMPANY (AEP) SHALL SPECIFY THE REQUIRED BURIAL DEPTH PER OPERATING COMPANY AS PRESCRIBED IN THE PRECEDING LIST:

COMPANY	BURIAL DEPTH
APCO	= REQUIRES A BURIAL DEPTH OF 30"
KYPCO	= REQUIRES A BURIAL DEPTH OF 30"
I&M	= REQUIRES A BURIAL DEPTH OF 30"
OHIO	= REQUIRES A BURIAL DEPTH OF 30"
TEXAS	= REQUIRES A BURIAL DEPTH OF 36"
PSO	= REQUIRES A BURIAL DEPTH OF 36"
SWEPCO	= REQUIRES A BURIAL DEPTH OF 36"

AND/OR CONFORM TO ANY OR ALL AUTHORITY HAVING JURISDICTION. THE POWER COMPANY (AEP) HAS PRESCRIBED THE BURIAL DEPTH SHALL NOT BE LESS THAN STATED DEPTH ON THE PRECEDING LIST UNLESS IMPOSSIBLE TO BE ACHIEVED OR IS SUPERSEDED BY LOCAL AUTHORITY HAVING JURISDICTION. IF THE DEPTH IS IMPOSSIBLE TO ACHIEVED AEP'S VERIFICATION WILL BE NEEDED. HOWEVER, BURIAL DEPTH NOT TO BE LESS THAN WHAT IS STATED IN THE NATIONAL ELECTRICAL CODE'S ARTICLES AND ARTICLE 300: 300.3(B) (1), 300.3 (C) (1) (2), TABLE 300.5, AND TABLE 300.50

SEE GENERAL CONDITION NOTES FOR POWER COMPANY AND CUSTOMER RESPONSIBILITIES

NOTES:

- THE NEUTRAL (GROUNDED SYSTEM) SHALL BE BONDED TO THE GROUND (GROUNDING SYSTEM) AT THE FIRST MEANS OF ATTACHMENT: DISCONNECT, OR METER BASE, AS PRESCRIBED PER OPERATING COMPANY AND BY NEC 250.24(A)
- OPERATING COMPANIES WHICH REQUIRE A 36" RADIUS BEND IN SERVICE ENTRANCE CONDUITS: APCO, KENTUCKY
- GROUNDING CONDUCTOR NOT PERMITTED IN THE METER SOCKET PER THE FOLLOWING OPERATING COMPANY: APCO, KENTUCKY.
- GROUNDING CONDUCTOR REQUIRED IN THE METER SOCKET ONLY PER THE FOLLOWING STATE: ARKANSAS, OKLAHOMA, LOUISIANA, AND TEXAS.
- GROUNDING CONDUCTOR PERMITTED IN THE METER BASE, DISCONNECT, MAIN DISTRIBUTION PANEL OR AS PRESCRIBED BY THE NEC 250.24(A): OHIO, I&M, SWEPCO.
- THE CUSTOMER SHALL HAVE A MINIMUM OF 2 DRIVEN GROUND RODS AT LEAST 6 FEET APART OR SHALL BE IN ACCORDANCE WITH NEC AND LOCAL REGULATIONS.
- EMERGENCY DISCONNECT IS REQUIREMENT IN ALL OPERATING COMPANIES THAT HAVE ADAPTED THE 2020 NEC CODE.
- ANTI-OXIDANT COMPOUNDS **SHALL NOT BE USED ON METER SOCKET BLADES OR METER BASE JAWS.** ANTI-OXIDANT COMPOUNDS CAN BE USED ON ALUMINUM CONDUCTORS AND METER BASE TERMINAL PER THE AHJ OF YOUR AREA.
- AEP REQUIRES THAT SURGE PROTECTION BE EMPLOYED AS PER THE 2020 NEC ARTICLE 230.67. SURGE PROTECTION IS THEREFORE REQUIRED IN ALL NEW SERVICE AND SERVICE UPDATES.
- PLEASE CHECK WITH YOUR LOCAL AHJ (AUTHORITY HAVING JURISDICTION) TO VERIFY WHETHER YOU ARE REQUIRED TO INSTALL A FULL SERVICE SURGE PROTECTION PER NEC 2020.

FOR FURTHER INFORMATION ON UTILITY REQUIREMENTS PLEASE CONTACT YOUR LOCAL AEP OPERATING COMPANY.

SINGLE PHASE UNDERGROUND SERVICE METER INSTALLATION

AMERICAN ELECTRIC POWER COMPANY  
METER STANDARDS

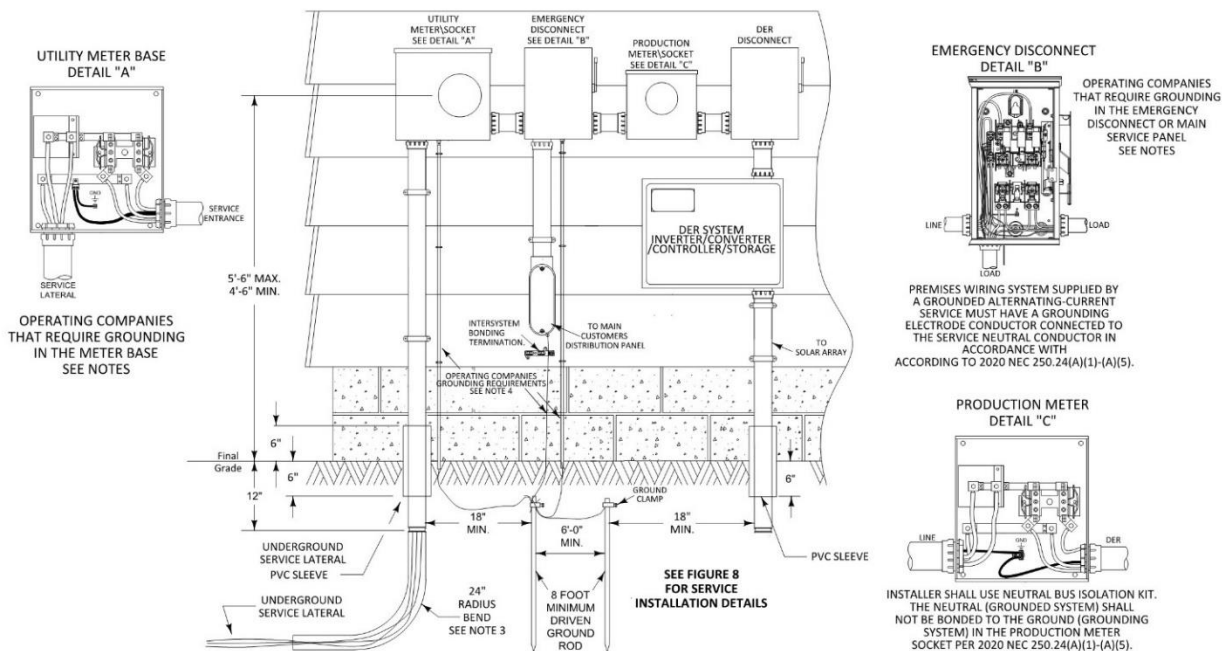

1. APPLICATION:

- A. CUSTOMER SHALL APPLY FOR INTERCONNECTION AS DETAILED IN AEP'S TIIR, AND PROVIDE ALL SYSTEM SPECIFICATIONS AND ONE-LINE DRAWING BEFORE INSTALLING ANY DER EQUIPMENT, AND SHALL SHOW PROOF OF MEETING OPERATING COMPANY'S ADOPTED ELECTRICAL CODE AT TIME OF COMMISSIONING.
- B. CUSTOMER SHALL SIGN AN AEP INTERCONNECTION SERVICE AGREEMENT, AND ANY NECESSARY PURCHASE POWER OR TARIFF AGREEMENTS.
- C. UTILITIES SHALL INSTALL ANY PRODUCTION METERS.
- D. ANY REQUIRED TELEMETRY EQUIPMENT SHALL BE INSTALLED AS AGREED UPON WITHIN THE INTERCONNECTION SERVICE AGREEMENT.
- E. CUSTOMER IS RESPONSIBLE FOR THE INSTALLATION AND MAINTENANCE OF ALL DER EQUIPMENT AND COMPLYING WITH ALL AHJ AND NEC REQUIREMENTS AND CODES.

2. PRODUCTION METER BASE SOCKET:

- A. CUSTOMER SHALL INSTALL THE PRODUCTION METER SOCKET WITH THEIR DER SYSTEM/SYSTEMS. THE PRODUCTION METER SOCKET WILL BE PURCHASED BY CUSTOMER, EXCEPT IN AREAS WHERE THE OPERATING COMPANY PROVIDES THIS COMPONENT.
- B. NO ADDITIONAL EQUIPMENT SHALL BE INSTALLED INSIDE THE PRODUCTION METER BASE AND WIRING MUST BE CONNECTED TO THE FACTORY SPECIFIED LUGS INSIDE METER BASE. CONNECTION WITHIN THE METER BASE SHALL ONLY BE DONE USING MANUFACTURER SPECIFIED EQUIPMENT.
- C. METER SOCKET SHALL NOT BE LOCATED IN OR OVER A WALKWAY, DRIVEWAY, OR ALLEY WHERE SUSCEPTIBLE TO DAMAGE OR HAZARDOUS TO PEDESTRIANS.
- D. THE PRODUCTION METER SOCKET IS REQUIRED TO FOLLOW ALL RULES AND REQUIREMENTS LISTED IN THE MOST RECENT VERSION OF THE AEP METER AND SERVICE GUIDE.
- E. PRODUCTION METER SOCKET MUST BE INSTALLED OUTDOORS IN A READILY ACCESSIBLE LOCATION. NO TREES OR SHRUBS SHALL BE PLANTED IN FRONT OF THE METER.
- F. ATTACH METER SOCKET WITH METAL OR LEAD ANCHORS ONLY; PLASTIC ANCHORS ARE NOT ACCEPTABLE.
- G. UTILITY SHALL PROVIDE THE BILLING AND PRODUCTION METERS WHICH WILL BE THE UTILITIES PROPERTY.

3. DER DISCONNECT:

- A. CUSTOMER SHALL PROVIDE AND INSTALL A READILY ACCESSIBLE, VISIBLE-BREAK ISOLATION DEVICE THAT SHALL BE LOCATED BETWEEN THE AREA EPS (ELECTRICAL POWER SYSTEM) AND EACH DER FOR ALL INSTALLATIONS.
- B. AEP'S FULL ISOLATION SERVICE REQUIREMENTS CAN BE FOUND IN SECTION 4.09 OF THE COMPANY'S TECHNICAL INTERCONNECTION INTEROPERABILITY REQUIREMENTS (TIIR) DOCUMENT FOUND HERE (INSERT HYPERLINK TO TIIR). INSTALLATION MUST COMPLY WITH ALL NEC, LOCAL CODES AND AUTHORITY HAVING JURISDICTION.

4. GENERAL INSTRUCTIONS:

- A. ENTRANCE AND EXIT CONDUITS SHALL BE INSTALLED USING THE KNOCKOUT HOLES PROVIDED BY THE MANUFACTURER.
- B. AREA SHALL BE CLEARED OF OBSTRUCTIONS 15" ON EACH SIDE AND 48" IN FRONT OF METER.
- C. THE NEUTRAL SHALL NOT BE BONDED TO THE GROUND IN THE PRODUCTION METER SOCKET.
- D. THE PRODUCTION METER SOCKET SHALL BE BONDED TO THE GROUNDING SYSTEM. INSTALLATION MUST COMPLY WITH ALL LOCAL CODES, NEC AND AHJ.

5. COMPLETION AND INSPECTION:

- A. ONCE SYSTEM HAS PASSED INSPECTION AND ALL THE PAPERWORK IS COMPLETED, AEP WILL SCHEDULE A TIME TO INSTALL A BI-DIRECTIONAL BILLING METER AND A PRODUCTION METER.
- B. THE SYSTEM SHALL NOT BE OPERATED IN PARALLEL WITH THE UTILITIES GRID UNTIL THE "PERMISSION TO OPERATE" LETTER HAS BEEN RECEIVED.

NOTES

1. THIS DRAWING APPLIES ONLY TO SINGLE-PHASE RESIDENTIAL SITES WITH EQUIPMENT RATED FOR 200 AMPS OR LESS. ISOLATION SWITCH REQUIRED FOR 277/480V INSTALLATIONS. TRANSFORMER-RATED METERING REQUIRED ON 277/480V INSTALLATIONS WHERE EXPECTED LOAD IS GREATER THAN 200 AMPS. CONSULT THE TIIR FOR FURTHER GUIDANCE.
2. THE NEUTRAL (GROUNDED SYSTEM) SHALL NOT BE BONDED TO THE GROUND (GROUNDING SYSTEM) IN THE PRODUCTION METER SOCKET ACCORDING TO NEC 2020 ARTICLE 250.24(A).
3. THE NEUTRAL (GROUNDED SYSTEM) SHALL BE BONDED TO THE GROUND (GROUNDING SYSTEMS) AT THE FIRST MEANS OF ATTACHMENT: DISCONNECT, OR METER BASE, AS PRESCRIBED PER OPERATING COMPANY AND BY NEC 250.24(A)
4. OPERATING COMPANIES WHICH REQUIRE 36" RADIUS BENDS IN SERVICE ENTRANCE CONDUITS: APCO, KENTUCKY
5. GROUNDING CONDUCTOR NOT PERMITTED IN THE METER SOCKET PER THE FOLLOWING OPERATING COMPANY: APCO, KENTUCKY
6. GROUNDING CONDUCTOR REQUIRED IN THE METER SOCKET ONLY PER THE FOLLOWING STATE: ARKANSAS, OKLAHOMA, LOUISIANA, AND TEXAS
7. GROUNDING CONDUCTOR PERMITTED IN THE METER BASE, DISCONNECT, MAIN DISTRIBUTION PANEL OR AS PRE-SCRIBED BY THE NEC 250.24(A): OHIO, I&M, SWPECO
8. THE CUSTOMER SHALL HAVE A MINIMUM OF 2 DRIVEN GROUND RODS AT LEAST 6 FEET APART OR SHALL BE IN ACCORDANCE WITH NEC AND LOCAL REGULATIONS.
9. THE PRODUCTION METER IS REQUIRED IN THE FOLLOWING STATES: OKLAHOMA
10. THE PRODUCTION METER IS NOT REQUIRED IN THE FOLLOWING STATES: ARKANSAS, INDIANA, KENTUCKY, LOUISIANA, MICHIGAN, OHIO, TENNESSEE, TEXAS, VIRGINIA, WEST VIRGINIA
11. PLEASE CHECK WITH YOUR LOCAL AHJ (AUTHORITY HAVING JURISDICTION) TO VERIFY WHETHER YOU ARE REQUIRED TO INSTALL A FULL SERVICE SURGE PROTECTION PER NEC 2020.
12. ANTI-OXIDANT COMPOUNDS SHALL NOT BE USE ON METER SOCKET BLADES OR METER BASE JAWS.
13. ANTI-OXIDANT COMPOUNDS CAN BE USED ON ALUMINUM CONDUCTORS AND METER BASE TERMINAL PER THE AHJ OF YOUR AREA.
14. AEP REQUIRES THAT SURGE PROTECTION BE EMPLOYED AS PER NEC 2020 ARTICLE 230.67. SURGE PROTECTION IN ALL NEW SERVICE AND SERVICE UPDATES
15. EMERGENCY DISCONNECT(S) REQUIRED IN ALL OPERATING COMPANIES THAT HAVE ADOPTED NEC 2020.

FOR FURTHER INFORMATION ON UTILITY REQUIREMENTS PLEASE CONTACT YOUR LOCAL AEP OPERATING COMPANY.

RESIDENTIAL DER SYSTEM WITH "PRODUCTION METER" DETAILS  
THIS DRAWING IS FOR PRODUCTION METER INSTALLATION ONLY, SEE THE AEP SERVICE GUIDE FOR ALL NEW SERVICE INSTALLATIONS

AMERICAN ELECTRIC POWER COMPANY  
METER STANDARDS

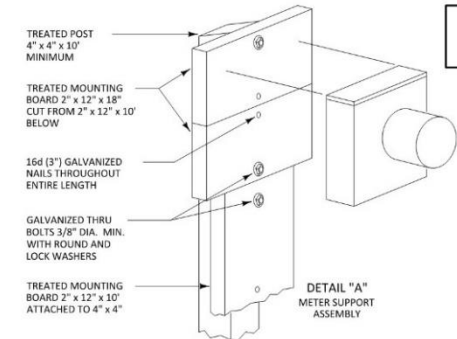

SEE GENERAL CONDITION NOTES FOR POWER COMPANY AND CUSTOMER RESPONSIBILITIES

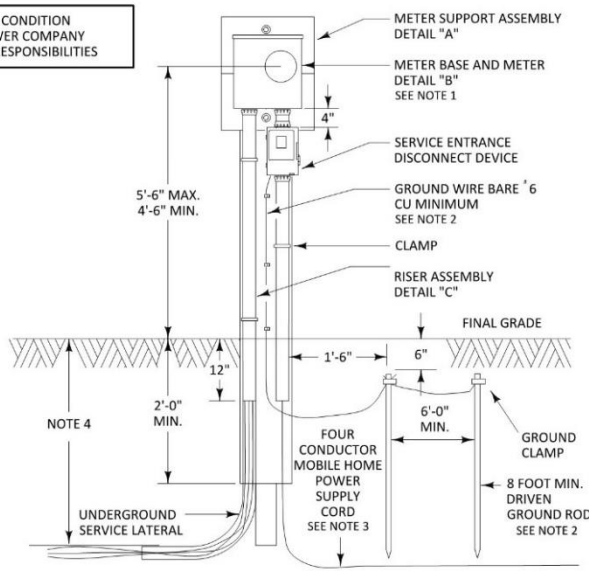

**GENERAL CONDITION NOTES:**

**THE POWER COMPANY WILL BE RESPONSIBLE FOR:**

- (a) SPECIFYING THE SERVICE POST LOCATION. NOTE: THE NATIONAL ELECTRICAL CODE (NEC) RECOMMENDS THAT THE SERVICE EQUIPMENT BE "IN SIGHT FROM" AND WITHIN 30 FEET OF THE MOBILE HOME. FOR RECREATIONAL VEHICLE SITE, REFER TO NEC ARTICLE 551.77.
- (b) INSTALLING AND REMOVING THE METER.
- (c) PROVIDING AND INSTALLING THE UNDERGROUND SERVICE TERRITORIES WHERE REQUIRED.

**THE CUSTOMER WILL BE RESPONSIBLE FOR:**

- (a) PROVIDING GROUNDING IN ACCORDANCE WITH NATIONAL ELECTRICAL CODE AND LOCAL REGULATIONS. GROUND SHALL BE CONNECTED IN METER ENCLOSURE OR CUSTOMER SWITCH.
- (b) PROVIDING AND SECURELY INSTALLING THE METER POST AND EQUIPMENT MOUNTING BOARD WITH THE FOLLOWING REQUIREMENTS:
  - 1. TREATED WITH AN EPA-REGISTERED PRESERVATIVE
  - 2. METER POST WITH DIMENSIONS AS SHOWN, WITH THE TOP CUT AT ANGLE AWAY FROM MOUNTING BOARD FOR WATER DRAINAGE
  - 3. EQUIPMENT MOUNTING BOARD WITH DIMENSIONS AS SHOWN FOR MOUNTING THE METERING AND SERVICE EQUIPMENT DEVICES. MOUNTING BOARD TO BE NAILED (SIZE 20D) TO METER POST EVERY 16 INCHES WITH ADDITIONAL THRU BOLTS LOCATED AS SHOWN. SERVICE ENTRANCE CONDUCTORS OR CABLES NOT TO EXIT THROUGH REAR OF METER BASE.
  - 4. SECURELY MOUNTING THE METER BASE IN A LEVEL AND PLUMB POSITION. METER MUST FACE STREET OR ACCESS WALKWAY.
- (c) PROVIDING AND INSTALLING THE SERVICE EQUIPMENT DISCONNECT DEVICE. TYPICAL CONFIGURATION SHOWN (OTHER CONFIGURATIONS AVAILABLE). THE DISCONNECT DEVICE IS TO HAVE OVERCURRENT PROTECTION AND TO BE IN A WEATHERPROOF ENCLOSURE. CUSTOMER TO SELECT NEC-APPROVED EQUIPMENT BEST SUITED TO CUSTOMER NEEDS.
- (d) PROVIDING AND SECURELY INSTALLING THE SERVICE LATERAL CONDUIT, SERVICE ENTRANCE CONDUIT AND POWER-SUPPLY CORD IN ACCORDANCE WITH NEC AND LOCAL CODES. NON-METALLIC CONDUIT PERMITTED IF INSTALLED IN ACCORDANCE WITH NEC ARTICLE 352 AND ACCEPTABLE TO THE AUTHORITY HAVING JURISDICTION (AHJ)

**GENERAL CONSTRUCTION NOTES:**

- 1. THIS INSTALLATION IS ALSO FOR MOBILE HOMES IN PARKS.
- 2. CUSTOMER IS TO SIZE GROUND WIRE ACCORDING TO NEC REQUIREMENTS. THE CUSTOMER SHALL HAVE A MINIMUM OF 2 DRIVEN GROUND RODS AT LEAST 6 FEET APART, OR ELSE INSTALL GROUNDING PER NEC.
- 3. A GROUNDING AS WELL AS A GROUNDED CONDUCTOR MUST EXTEND BETWEEN THE MOBILE HOME AND ITS ADJACENT SERVICE EQUIPMENT. NEITHER THE FRAME OF THE MOBILE HOME NOR THE FRAME OF ANY DISTRIBUTION PANEL OR APPLIANCE MAY BE CONNECTED TO THE NEUTRAL (GROUNDED) CONDUCTOR IN THE MOBILE HOME. THE GROUNDING AND GROUNDED CONDUCTORS ARE BONDED TOGETHER ONLY ON THE SUPPLY SIDE OF THE SERVICE DISCONNECT DEVICE. REFER TO NEC ARTICLE 550 - GROUNDING.
- 4. ANTI-OXIDANT COMPOUNDS **SHALL NOT BE USED ON METER SOCKET BLADES OR METER BASE JAWS.**  
ANTI-OXIDANT COMPOUNDS CAN BE USED ON ALUMINUM CONDUCTORS AND METER BASE TERMINAL PER THE AHJ OF YOUR AREA.
- 5. AEP REQUIRES THAT SURGE PROTECTION BE EMPLOYED AS PER 2020 NEC ARTICLE 230.67. SURGE PROTECTION REQUIRED IN ALL NEW SERVICE AND SERVICE UPDATES.

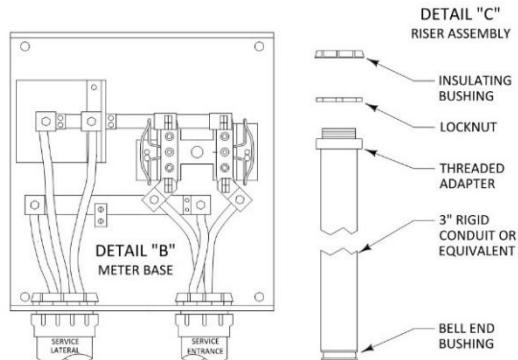

**GENERAL CONSTRUCTION NOTES (CONT.):**

- 6. BURIAL DEPTH IS THE DISTANCE BETWEEN FINAL GRADE AND THE TOP OF THE BURIED CABLE OR CONDUIT. THE POWER COMPANY (AEP) SHALL SPECIFY THE REQUIRED BURIAL DEPTH PER OPERATING COMPANY AS PRESCRIBED IN THE PROCEEDING LIST:

COMPANY	BURIAL DEPTH
APCO	= REQUIRES A BURIAL DEPTH OF 30"
KYPCO	= REQUIRES A BURIAL DEPTH OF 30"
I&M	= REQUIRES A BURIAL DEPTH OF 30"
OHIO	= REQUIRES A BURIAL DEPTH OF 30"
TEXAS	= REQUIRES A BURIAL DEPTH OF 36"
PSO	= REQUIRES A BURIAL DEPTH OF 36"
SWEPSCO	= REQUIRES A BURIAL DEPTH OF 36"

AND/OR CONFORM TO ANY OR ALL AUTHORITY HAVING JURISDICTION. THE POWER COMPANY (AEP) HAS PRESCRIBED THE BURIAL DEPTH SHALL NOT BE LESS THAN STATED DEPTH ON THE PRECEDING LIST UNLESS IMPOSSIBLE TO BE ACHIEVED OR IS SUPERSEDED BY LOCAL AUTHORITY HAVING JURISDICTION. IF THE DEPTH IS IMPOSSIBLE TO ACHIEVED AEP'S VERIFICATION WILL BE NEEDED. HOWEVER, BURIAL DEPTH NOT TO BE LESS THAN WHAT IS STATED IN THE NATIONAL ELECTRICAL CODE'S ARTICLES AND ARTICLE 300: 300.3(B) (1), 300.3 (C) (1) (2), TABLE 300.5, AND TABLE 300.50

PROVIDING GROUNDING IN ACCORDANCE WITH NATIONAL ELECTRICAL CODE AND LOCAL REGULATIONS. GROUND SHALL BE CONNECTED IN METER ENCLOSURE OR CUSTOMER SWITCH.

FOR FURTHER INFORMATION ON UTILITY REQUIREMENTS PLEASE CONTACT YOUR LOCAL AEP OPERATING COMPANY.

SINGLE MOBILE HOME UNDERGROUND SERVICE

AMERICAN ELECTRIC POWER COMPANY  
METER STANDARDS

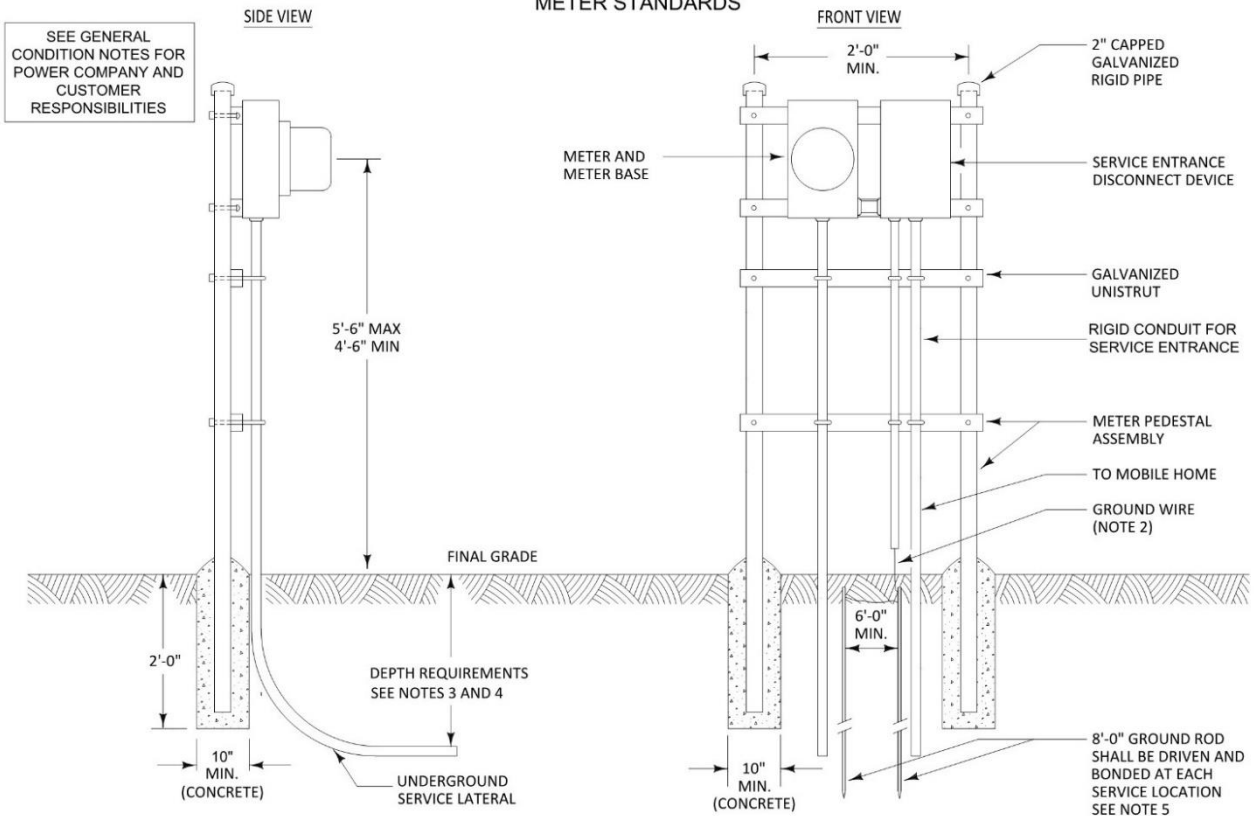

GENERAL CONDITION NOTES:

THE POWER COMPANY WILL BE RESPONSIBLE FOR:

- (a) SPECIFYING THE METER PEDESTAL LOCATION. NOTE: THE NATIONAL ELECTRICAL CODE (NEC) RECOMMENDS THAT THE SERVICE EQUIPMENT BE "IN SIGHT FROM" AND WITHIN 30'-0" OF THE MOBILE HOME.
- (b) INSTALLING AND REMOVING THE METER.
- (c) PROVIDING AND INSTALLING THE UNDERGROUND SERVICE LATERAL CONDUCTORS.

THE CUSTOMER WILL BE RESPONSIBLE FOR:

- (a) PROVIDING AND INSTALLING THE METER PEDESTAL.
- (b) PROVIDING AND INSTALLING THE METER BASE.
- (c) PROVIDING AN ADEQUATE GROUND TO THE SERVICE EQUIPMENT DISCONNECT DEVICE. GROUND IN ACCORDANCE WITH ARTICLE 250 OF THE NATIONAL ELECTRICAL CODE (NEC).
- (d) SECURELY INSTALLING THE METER PEDESTAL AS SHOWN.
- (e) SECURELY MOUNTING THE METER BASE IN A LEVEL AND PLUMB POSITION. METER MUST FACE STREET OR ACCESS WALKWAY.
- (f) PROVIDING AND INSTALLING THE SERVICE EQUIPMENT DISCONNECT DEVICE.
- (g) PROVIDING SERVICE ENTRANCE CONDUCTORS OF SUFFICIENT AMPACITY TO SERVE THE CONNECTED LOAD ACCORDING TO THE CURRENT NEC.

GENERAL CONSTRUCTION NOTES:

- 1. THIS INSTALLATION IS ALSO FOR MOBILE HOMES IN PARKS.
- 2. CUSTOMER IS TO SIZE GROUND WIRE ACCORDING TO NEC REQUIREMENTS.
- 3. **ANTI-OXIDANT COMPOUNDS SHALL NOT BE USED ON METER SOCKET BLADES OR METER BASE JAWS.**

ANTI-OXIDANT COMPOUNDS CAN BE USED ON ALUMINUM CONDUCTORS AND METER BASE TERMINAL PER THE AHJ OF YOUR AREA.

**FOR FURTHER INFORMATION ON UTILITY REQUIREMENTS PLEASE CONTACT YOUR LOCAL AEP OPERATING COMPANY.**

- 3. BURIAL DEPTH IS THE DISTANCE BETWEEN FINAL GRADE AND THE TOP OF THE BURIED CABLE OR CONDUIT. THE POWER COMPANY (AEP) SHALL SPECIFY THE REQUIRED BURIAL DEPTH PER OPERATING COMPANY AS PRESCRIBED IN THE PROCEEDING LIST:

COMPANY	BURIAL DEPTH
APCO	= REQUIRES A BURIAL DEPTH OF 30"
KYPCO	= REQUIRES A BURIAL DEPTH OF 30"
I&M	= REQUIRES A BURIAL DEPTH OF 30"
OHIO	= REQUIRES A BURIAL DEPTH OF 30"
TEXAS	= REQUIRES A BURIAL DEPTH OF 36"
PSO	= REQUIRES A BURIAL DEPTH OF 36"
SWPCO	= REQUIRES A BURIAL DEPTH OF 36"

AND/OR CONFORM TO ANY OR ALL AUTHORITY HAVING JURISDICTION. THE POWER COMPANY (AEP) HAS PRESCRIBED THE BURIAL DEPTH SHALL NOT BE LESS THAN STATED BY ARTICLE 300-5 OF THE NEC. A GROUNDING AS WELL AS A GROUNDED CONDUCTOR MUST EXTEND BETWEEN THE MOBILE HOME AND ITS ADJACENT SERVICE EQUIPMENT. NEITHER THE FRAME OF THE MOBILE HOME NOR THE FRAME OF ANY DISTRIBUTION PANEL OR APPLIANCE MAY BE CONNECTED TO THE NEUTRAL (GROUNDED) CONDUCTOR IN THE MOBILE HOME. THE GROUNDING AND GROUNDED CONDUCTORS ARE BONDED TOGETHER ONLY ON THE SUPPLY SIDE OF THE SERVICE DISCONNECT DEVICE. REFER TO ARTICLE 550 OF THE NEC - GROUNDING.

- 4. BURIAL DEPTH TO COMPLY WITH LOCAL CODES. 2'-0" MIN. IS CONSIDERED ADEQUATE BY ARTICLE 300-5 OF THE NEC. A GROUNDING AS WELL AS A GROUNDED CONDUCTOR MUST EXTEND BETWEEN THE MOBILE HOME AND ITS ADJACENT SERVICE EQUIPMENT. NEITHER THE FRAME OF THE MOBILE HOME NOR THE FRAME OF ANY DISTRIBUTION PANEL OR APPLIANCE MAY BE CONNECTED TO THE NEUTRAL (GROUNDED) CONDUCTOR IN THE MOBILE HOME. THE GROUNDING AND GROUNDED CONDUCTORS ARE BONDED TOGETHER ONLY ON THE SUPPLY SIDE OF THE SERVICE DISCONNECT DEVICE. REFER TO ARTICLE 550 OF THE NEC - GROUNDING.
- 5. CUSTOMER GROUNDING SHALL BE IN ACCORDANCE WITH NEC AND LOCAL REGULATIONS. IN ARKANSAS, OKLAHOMA, LOUISIANA, AND TEXAS, THE GROUND WIRE SHALL BE CONNECTED IN THE METER SOCKET IN CONDUIT WHERE REQUIRED. THE CUSTOMER SHALL HAVE A MINIMUM OF 2 DRIVEN GROUND RODS AT LEAST 6 FEET APART.
- 6. AEP REQUIRES THAT SURGE PROTECTION BE EMPLOYED AS PER THE NEC ARTICLE 230.67 (BASE ON THE 2020). SURGE PROTECTION IN ALL NEW SERVICE AND SERVICE UPDATES
- 7. PLEASE CHECK WITH YOUR LOCAL AHJ (AUTHORITY HAVING JURISDICTION) TO VERIFY WHETHER YOU ARE REQUIRED TO INSTALL A FULL SERVICE SURGE PROTECTION PER NEC 2020.

SINGLE MOBILE HOME UNDERGROUND SERVICE  
(ALTERNATE METER PEDESTAL)

AMERICAN ELECTRIC POWER COMPANY  
METER STANDARDS

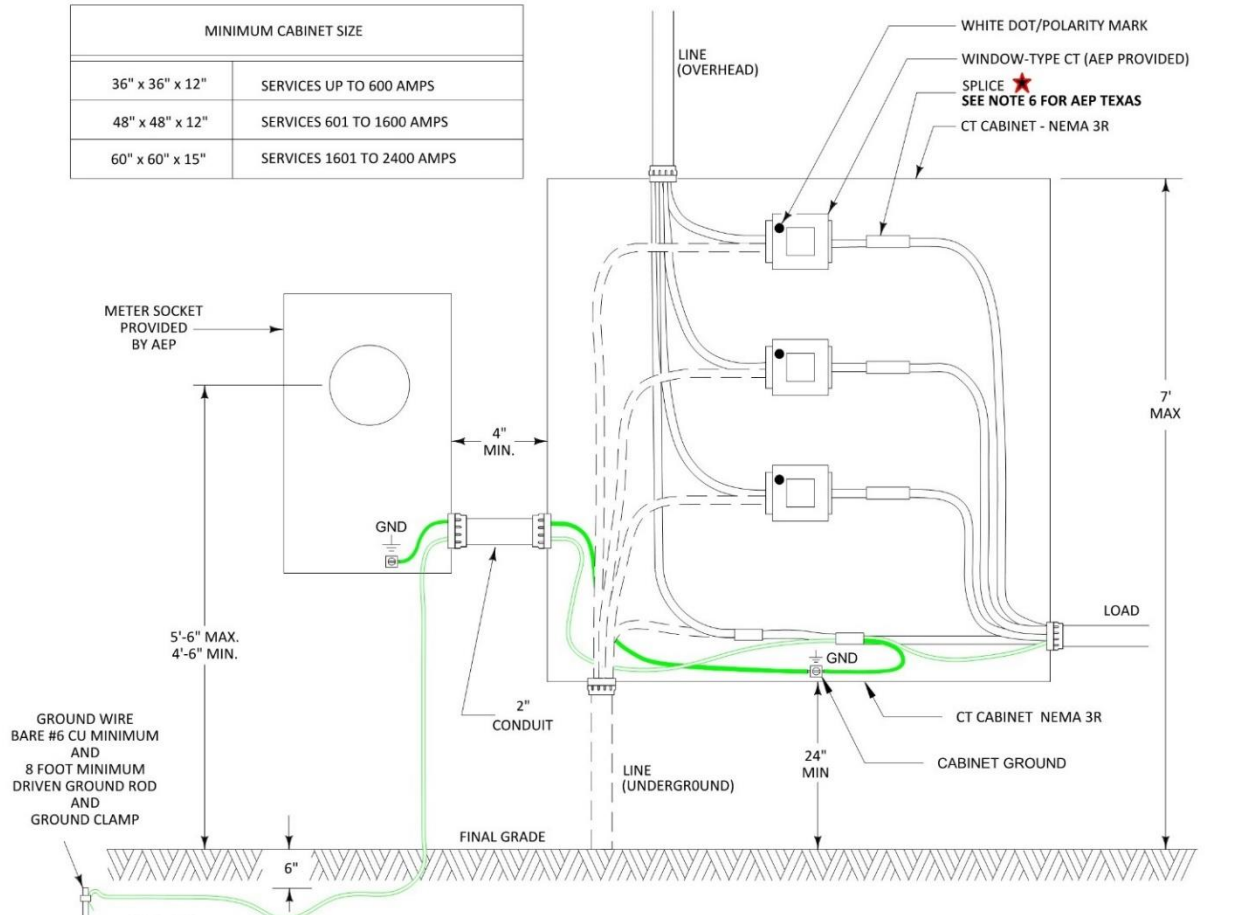

**NOTES**

1. CT CABINET, FURNISHED AND INSTALLED BY CUSTOMER, SHALL BE OF SUBSTANTIAL STRENGTH WITH CORROSION PROTECTION, SUCH AS PAINTED GALVANIZED STEEL NEMA 3R. ALUMINUM OR FIBER REINFORCED POLYESTER ENCLOSURES MUST BE USED IN CORROSIVE AREAS. CT CABINET SHALL BE FITTED WITH HINGED DOOR(S) AND SHALL HAVE PROVISIONS FOR INSTALLING A COMPANY PADLOCK AND SEAL THE INSIDE BACK OF THE CABINET SHALL BE ENTIRELY COVERED BY 3/4" TREATED PLYWOOD FOR MOUNTING THE CURRENT TRANSFORMERS OR (AEP TEXAS) SUITABLE MOUNTING BRACKETS MAY BE PROVIDED. A GROUNDING LUG SHALL BE PROVIDED TO GROUND THE CABINET.
2. THE WHITE DOT POLARITY MARK ON THE CT SHALL BE TOWARD THE ENERGY SOURCE OR LINE SIDE.
3. CUSTOMER SHOULD MOUNT THE METER SOCKET OR CABINET NEXT TO THE CT CABINET AND INSTALL 2" CONDUIT BETWEEN THE TWO. IF THE METER SOCKET CANNOT BE INSTALLED NEXT TO THE CT CABINET, IT MAY BE LOCATED UP TO 20 FEET AWAY WITH COMPANY METER SERVICES APPROVAL. 2" CONDUIT SHALL CONNECT THE SOCKET AND CT CABINET.
4. THE CT CABINET AND METER SOCKET SHALL BE GROUNDED. THE METER SOCKET AND CT CABINET SHALL BE BONDED THROUGH A SEPARATE EQUIPMENT-GROUNDING CONDUCTOR CONNECTED TO THE GROUNDED SERVICE CONDUCTOR (USUALLY THE NEUTRAL). IF A GROUNDED SERVICE CONDUCTOR DOES NOT EXIST THEN GROUNDING AND BONDING OF METERING EQUIPMENT MUST BE ESTABLISHED THROUGH A GROUNDING ELECTRODE SYSTEM ESTABLISHED AT THE POINT OF SERVICE. IN SOME JURISDICTIONS THE GROUNDING OF THE METER SOCKET AND INSTRUMENT TRANSFORMER ENCLOSURE WILL BE SUPPLEMENTED WITH THE USE OF A DRIVEN GROUND ROD IN ADDITION TO BONDING TO THE GROUNDED SERVICE CONDUCTOR. REFER TO SECTION 9 FOR CT CABINET SPECIFICATIONS.
5. COMPANY WILL INSTALL THE SECONDARY WIRING BETWEEN THE CT AND THE METER SOCKET.
6. THE CONDUCTOR SPLICE SHALL BE MADE WITH BOLTED CONNECTIONS FURNISHED AND INSTALLED BY CUSTOMER WHERE REQUIRED. **WHERE IN AEP TEXAS THE CUSTOMER OWNS AND INSTALLS BOTH THE LINE AND LOAD CONDUCTORS, THE CONDUCTOR SHALL PASS THROUGH THE CT CABINET WITHOUT SPLICES.**
7. FOR CT CABINET CLEARANCES REFERENCE FIGURE M.S.\_F020A
8. FOR CT CABINET CLEARANCES ON CATWALK INSTALLATIONS REFERCE FIGURE M.S.\_F021A

★ SPLICING IS REQUIRED IN AEP: KENTUCKY, OHIO, OKLAHOMA.

**FOR FURTHER INFORMATION ON UTILITY REQUIREMENTS PLEASE CONTACT YOUR LOCAL AEP OPERATING COMPANY.**

CURRENT TRANSFORMER CABINETS  
OVERHEAD OR UNDERGROUND SERVICE  
WINDOW TYPE CTS

AMERICAN ELECTRIC POWER COMPANY  
METER STANDARDS

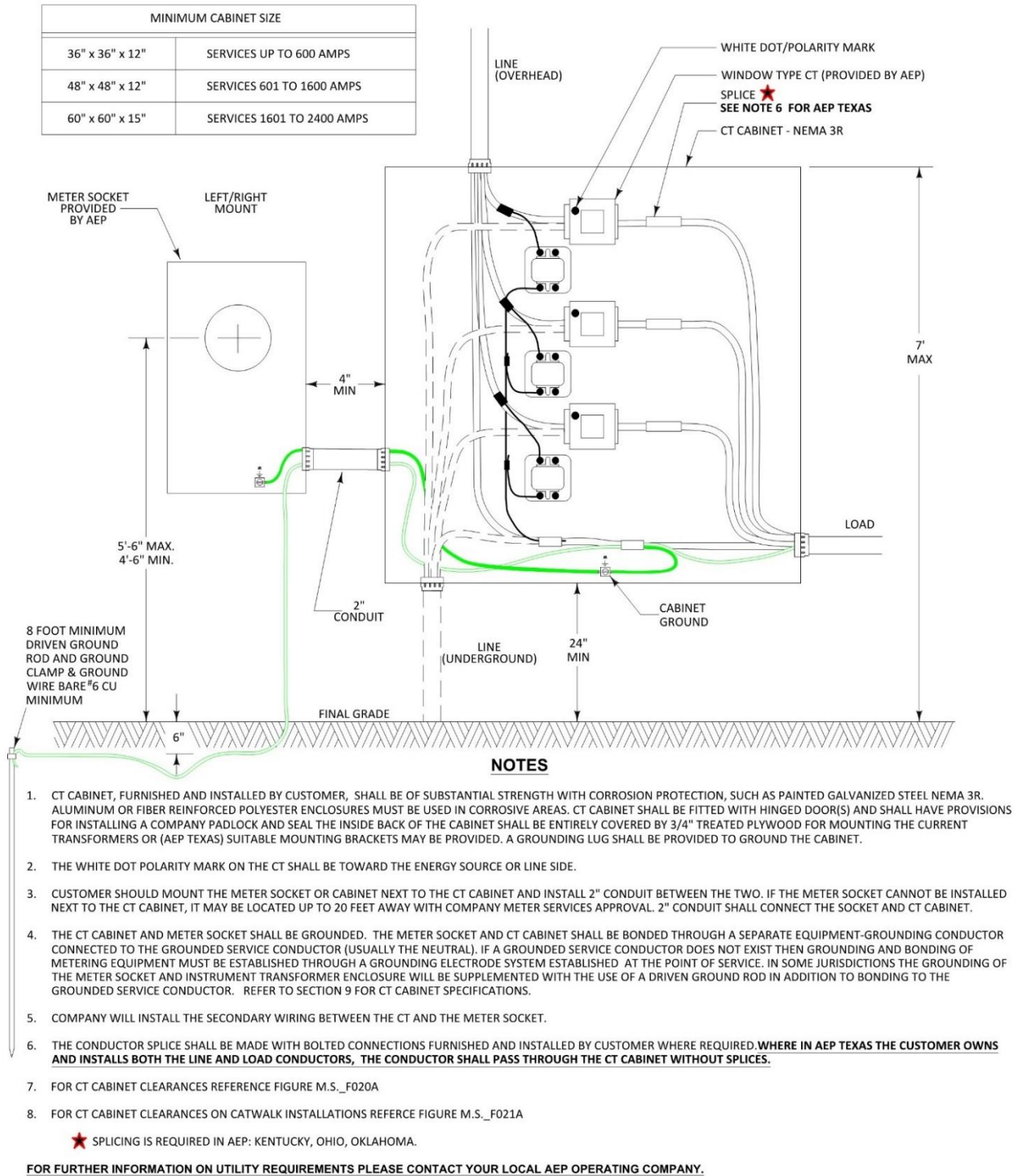

CURRENT TRANSFORMER CABINETS OVERHEAD OR UNDERGROUND SERVICE  
WINDOW TYPE CTS AND VTS 277/480 VOLT

AMERICAN ELECTRIC POWER COMPANY  
METER STANDARDS

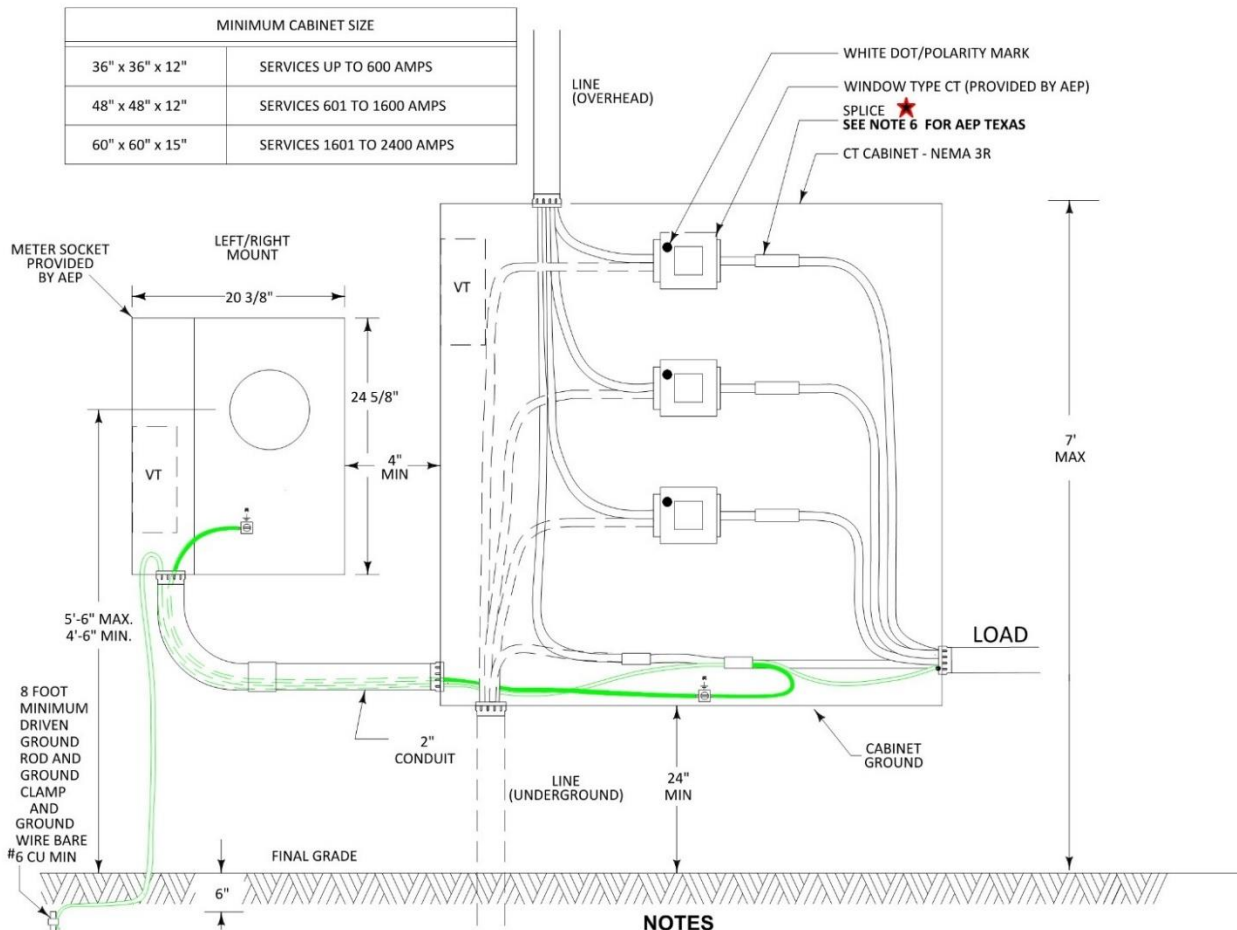

NOTES

1. CT CABINET, FURNISHED AND INSTALLED BY CUSTOMER, SHALL BE OF SUBSTANTIAL STRENGTH WITH CORROSION PROTECTION, SUCH AS PAINTED GALVANIZED STEEL NEMA 3R. ALUMINUM OR FIBER REINFORCED POLYESTER ENCLOSURES MUST BE USED IN CORROSIVE AREAS. CT CABINET SHALL BE FITTED WITH HINGED DOOR(S) AND SHALL HAVE PROVISIONS FOR INSTALLING A COMPANY PADLOCK AND SEAL THE INSIDE BACK OF THE CABINET SHALL BE ENTIRELY COVERED BY 3/4" TREATED PLYWOOD FOR MOUNTING THE CURRENT TRANSFORMERS OR (AEP TEXAS) SUITABLE MOUNTING BRACKETS MAY BE PROVIDED. A GROUNDING LUG SHALL BE PROVIDED TO GROUND THE CABINET.
2. THE WHITE DOT POLARITY MARK ON THE CT SHALL BE TOWARD THE ENERGY SOURCE OR LINE SIDE.
3. CUSTOMER SHOULD MOUNT THE METER SOCKET OR CABINET NEXT TO THE CT CABINET AND INSTALL 2" CONDUIT BETWEEN THE TWO. IF THE METER SOCKET CANNOT BE INSTALLED NEXT TO THE CT CABINET, IT MAY BE LOCATED UP TO 20 FEET AWAY WITH COMPANY METER SERVICES APPROVAL. 2" CONDUIT SHALL CONNECT THE SOCKET AND CT CABINET.
4. THE CT CABINET AND METER SOCKET SHALL BE GROUNDED. THE METER SOCKET AND CT CABINET SHALL BE BONDED THROUGH A SEPARATE EQUIPMENT-GROUNDING CONDUCTOR CONNECTED TO THE GROUNDED SERVICE CONDUCTOR (USUALLY THE NEUTRAL). IF A GROUNDED SERVICE CONDUCTOR DOES NOT EXIST THEN GROUNDING AND BONDING OF METERING EQUIPMENT MUST BE ESTABLISHED THROUGH A GROUNDING ELECTRODE SYSTEM ESTABLISHED AT THE POINT OF SERVICE. IN SOME JURISDICTIONS THE GROUNDING OF THE METER SOCKET AND INSTRUMENT TRANSFORMER ENCLOSURE WILL BE SUPPLEMENTED WITH THE USE OF A DRIVEN GROUND ROD IN ADDITION TO BONDING TO THE GROUNDED SERVICE CONDUCTOR. REFER TO SECTION 9 FOR CT CABINET SPECIFICATIONS.
5. COMPANY WILL INSTALL THE SECONDARY WIRING BETWEEN THE CT AND THE METER SOCKET.
6. THE CONDUCTOR SPLICE SHALL BE MADE WITH BOLTED CONNECTIONS FURNISHED AND INSTALLED BY CUSTOMER WHERE REQUIRED. **WHERE IN AEP TEXAS THE CUSTOMER OWNS AND INSTALLS BOTH THE LINE AND LOAD CONDUCTORS, THE CONDUCTOR SHALL PASS THROUGH THE CT CABINET WITHOUT SPLICES.**
7. FOR CT CABINET CLEARANCES REFERENCE FIGURE M.S.\_F020A
8. FOR CT CABINET CLEARANCES ON CATWALK INSTALLATIONS REFERENCE FIGURE M.S.\_F021A

★ SPLICING IS REQUIRED IN AEP: KENTUCKY, OHIO, OKLAHOMA.

**FOR FURTHER INFORMATION ON UTILITY REQUIREMENTS PLEASE CONTACT YOUR LOCAL AEP OPERATING COMPANY.**

CURRENT TRANSFORMER CABINETS OVERHEAD OR UNDERGROUND SERVICE  
WINDOW TYPE CTS AND VTS 277/480 VOLT

AMERICAN ELECTRIC POWER COMPANY  
METER STANDARDS

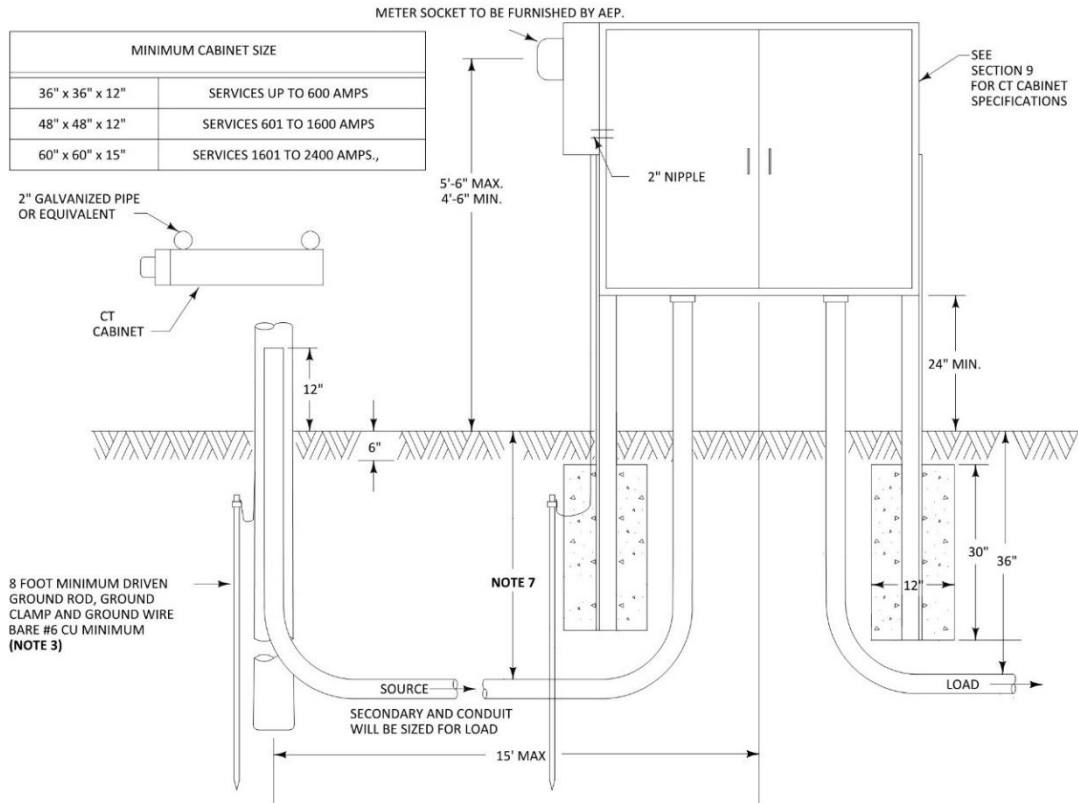

NOTES

1. CT CABINET, FURNISHED AND INSTALLED BY CUSTOMER, SHALL BE OF SUBSTANTIAL STRENGTH WITH CORROSION PROTECTION, SUCH AS PAINTED GALVANIZED STEEL NEMA 3R. ALUMINUM OR FIBER REINFORCED POLYESTER ENCLOSURES MUST BE USED IN CORROSIVE AREAS. CT CABINET SHALL HAVE PROVISIONS FOR INSTALLING A COMPANY PADLOCK AND SEAL. THE INSIDE BACK OF THE CABINET SHALL BE ENTIRELY COVERED BY 3/4" TREATED PLYWOOD FOR MOUNTING THE CURRENT TRANSFORMERS OR (AEP TEXAS) SUITABLE MOUNTING BRACKETS MAY BE PROVIDED. A GROUNDING LUG SHALL BE PROVIDED TO GROUND THE CABINET.
2. THE WHITE DOT POLARITY MARK ON THE CT SHALL BE TOWARD THE ENERGY SOURCE OR LINE SIDE.
3. CUSTOMER SHOULD MOUNT THE METER SOCKET ON THE CT CABINET AND INSTALL 2" NIPPLE BETWEEN THE TWO.
4. THE CT CABINET AND METER SOCKET SHALL BE GROUNDED. THE METER SOCKET AND CT CABINET SHALL BE BONDED THROUGH A SEPARATE EQUIPMENT-GROUNDING CONDUCTOR CONNECTED TO THE GROUNDED SERVICE CONDUCTOR (USUALLY THE NEUTRAL). IF A GROUNDED SERVICE CONDUCTOR DOES NOT EXIST THEN GROUNDING AND BONDING OF METERING EQUIPMENT MUST BE ESTABLISHED THROUGH A GROUNDING ELECTRODE SYSTEM ESTABLISHED AT THE POINT OF SERVICE. IN SOME JURISDICTIONS THE GROUNDING OF THE METER SOCKET AND INSTRUMENT TRANSFORMER ENCLOSURE WILL BE SUPPLEMENTED WITH THE USE OF A DRIVEN GROUND ROD IN ADDITION TO BONDING TO THE GROUNDED SERVICE CONDUCTOR. REFER TO SECTION 9 FOR CT CABINET SPECIFICATIONS.
5. COMPANY WILL INSTALL THE METER CONTROL CABLE BETWEEN THE CT AND THE METER SOCKET.
6. THE CONDUCTOR SPLICE SHALL BE MADE WITH BOLTED CONNECTIONS FURNISHED AND INSTALLED BY CUSTOMER WHERE REQUIRED. **IN AEP TEXAS NORTH AND CENTRAL WHERE THE CUSTOMER OWNS AND INSTALLS BOTH THE LINE AND LOAD CONDUCTORS, THE CONDUCTOR SHALL PASS THROUGH THE CTs WITHOUT SPLICE.**
7. THE COMPANY WILL BE RESPONSIBLE FOR: DESIGNATING THE LOCATION FOR THE TRENCH AND THE METER, PROVIDING AND INSTALLING THE UNDERGROUND SERVICE LATERAL IN SERVICE TERRITORIES WHERE REQUIRED, PROVIDING THE METER BASE TO THE CUSTOMER WHERE REQUIRED.
8. THE CUSTOMER WILL BE RESPONSIBLE FOR PROVIDING AND INSTALLING THE RISER ASSEMBLY. RISER ASSEMBLY TO CONSIST OF AN INSULATING BUSHING, LOCKNUT, THREADED ADAPTER, GALVANIZED OR SCHEDULE 80 PVC CONDUIT WITH BELL END AND CLAMP. INSTALLATION OF EQUIPMENT TO BE IN ACCORDANCE WITH POWER COMPANY STANDARDS AND/OR LOCAL ORDINANCES OR CODES.

9. BURIAL DEPTH IS THE DISTANCE BETWEEN FINAL GRADE AND THE TOP OF THE BURIED CABLE OR CONDUIT. THE POWER COMPANY (AEP) SHALL SPECIFY THE REQUIRED BURIAL DEPTH PER OPERATING COMPANY AS PRESCRIBED IN THE PRECEDING LIST:

COMPANY	BURIAL DEPTH
APCO	= REQUIRES A BURIAL DEPTH OF 30"
KYPCO	= REQUIRES A BURIAL DEPTH OF 30"
I&M	= REQUIRES A BURIAL DEPTH OF 30"
OHIO	= REQUIRES A BURIAL DEPTH OF 30"
TEXAS	= REQUIRES A BURIAL DEPTH OF 36"
PSO	= REQUIRES A BURIAL DEPTH OF 36"
SWEPCO	= REQUIRES A BURIAL DEPTH OF 36"

AND/OR CONFORM TO ANY OR ALL AUTHORITY HAVING JURISDICTION. THE POWER COMPANY (AEP) HAS PRESCRIBED THE BURIAL DEPTH SHALL NOT BE LESS THAN STATED DEPTH ON THE PRECEDING LIST UNLESS IMPOSSIBLE TO BE ACHIEVED OR IS SUPERSEDED BY LOCAL AUTHORITY HAVING JURISDICTION. IF THE DEPTH IS IMPOSSIBLE TO ACHIEVED AEP'S VERIFICATION WILL BE NEEDED. HOWEVER, NOT TO BE LESS THAN WHAT IS STATED IN THE NATIONAL ELECTRICAL CODE'S ARTICLE 300: 300.3(B) (1), 300.3 (C) (1) (2), TABLE 300.5, AND TABLE 300.50

10. FOR CT CABINET CLEARANCES REFERENCE FIGURE M.S.\_F020A

**FOR FURTHER INFORMATION ON UTILITY REQUIREMENTS PLEASE CONTACT YOUR LOCAL AEP OPERATING COMPANY.**

CURRENT TRANSFORMER CABINET  
FREE-STANDING OVERHEAD TO UNDERGROUND SERVICE



AMERICAN ELECTRIC POWER COMPANY  
METER STANDARDS

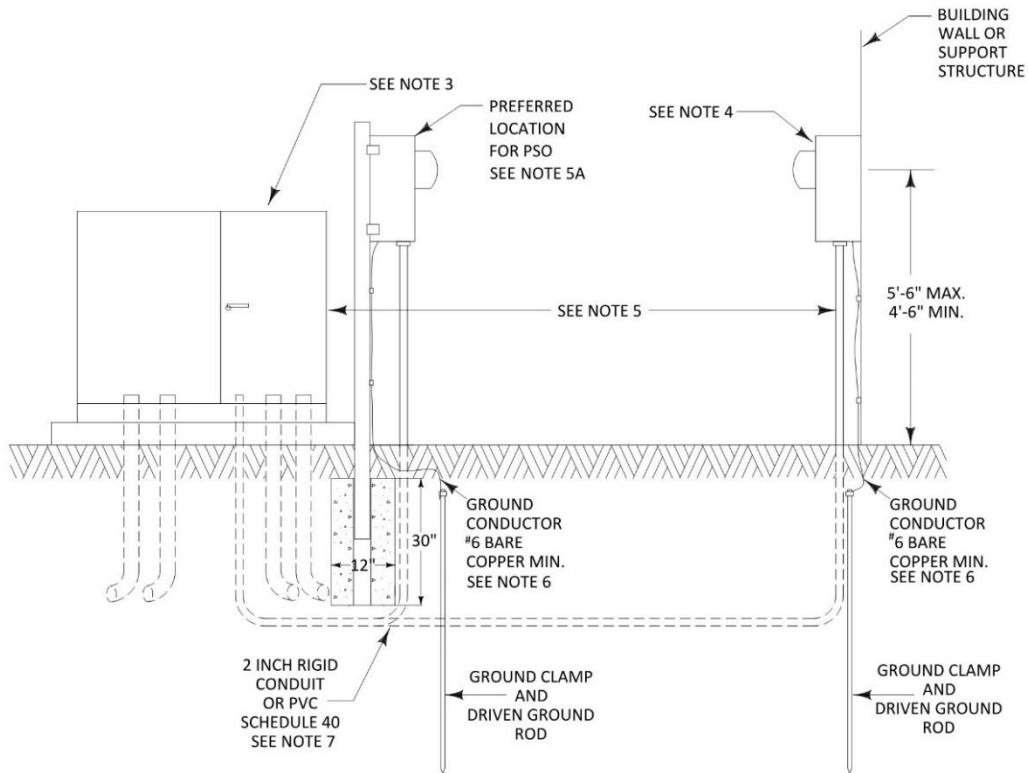

NOTES:

1. INSTRUMENT TRANSFORMERS (CTs) SHALL BE ARE FURNISHED AND INSTALLED BY COMPANY PRIOR TO CONNECTION OF CUSTOMER SERVICE CABLES.
2. CUSTOMER SHALL PROVIDE NEMA TYPE TERMINAL LUGS FOR CUSTOMER-OWNED SERVICE CONDUCTORS WHERE REQUIRED. POWER COMPANY TO SECURE CABLE TERMINATIONS. STACKING LUGS MAY BE REQUIRED TO ACCOMMODATE THE NUMBER OF SERVICE CONDUCTORS PER TRANSFORMER BUSHING.
3. THIS STANDARD IS APPLICABLE FOR A SINGLE CUSTOMER PAD-MOUNTED TRANSFORMER.
4. COMPANY PROVIDES METER SOCKET TO BE INSTALLED BY CUSTOMER, OR BY CONTRACTOR, IN A PLUMB POSITION AT LOCATION. IF USING REMOVABLE CORROSION-RESISTANT FASTENERS, REFER TO FIGURE M.S.\_F014. FOR WORKING DISTANCE CLEARANCES REFER TO FIGURE M.S.\_F020.
5. TRANSFORMER PAD LOCATION AND LOCATION OF CONDUITS FOR CONDUCTOR/METER CONTROL CABLE TO BE SPECIFIED BY AEP. THE METER LOCATION IS TO BE A MINIMUM OF 3 FEET AWAY AND WITHIN 25 FEET OF THE TRANSFORMER PAD LOCATION. WHEN THE BUILDING IS LOCATED AT A DISTANCE GREATER THAN 25 FEET FROM THE TRANSFORMER PAD LOCATION, THE METER IS TO BE MOUNTED ON A SUPPORT STRUCTURE AT A LOCATION WHERE THE DISTANCE FROM THE TRANSFORMER PAD LOCATION IS NOT GREATER THAN 25 FEET. FOR FREE-STANDING METERING FACILITIES REQUIREMENTS, REFER TO FIGURE M.S.\_F014.
- 5.A. PSO REQUIRES THE METER LOCATION TO BE SECURED TO THE SIDE OF THE PAD WITH AN ANCHORING SYSTEM ON THE SECONDARY SIDE OF THE TRANSFORMER PAD, IN ADDITION TO BEING ENCASED IN CONCRETE OR LOCATED ON THE BUILDING STRUCTURE, IF WITHIN 25 FEET OF THE TRANSFORMER PAD LOCATION. REFER TO FIGURE M.S.\_F014.
6. THE METER SOCKET SHALL BE GROUNDED. THE METER SOCKET SHALL BE BONDED THROUGH A SEPARATE EQUIPMENT-GROUNDING CONDUCTOR CONNECTED TO THE GROUNDED SERVICE CONDUCTOR (USUALLY THE NEUTRAL). IN SOME JURISDICTIONS THE GROUNDING OF THE METER SOCKET WILL B E SUPPLEMENTED WITH THE USE OF A DRIVEN GROUND ROD IN ADDITION TO BONDING TO THE GROUNDED SERVICE CONDUCTOR.
7. SCHEDULE 80 RIGID CONDUIT REQUIRED FOR DRIVEWAYS AND PARKING LOTS.
8. THE CUSTOMER SHALL BE RESPONSIBLE FOR PULLING CONTROL CABLE AND EQUIPMENT GROUNDING IN CONDUIT FROM METER SOCKET TO PAD-MOUNT TRANSFORMER. IF CONTROL CABLE IS NOT AVAILABLE, A PULL STRING SHALL BE PROVIDED BY THE CUSTOMER.

FOR FURTHER INFORMATION ON UTILITY REQUIREMENTS PLEASE CONTACT YOUR LOCAL AEP OPERATING COMPANY.

PAD-MOUNT TRANSFORMER METERING INSTALLATION

AMERICAN ELECTRIC POWER COMPANY  
METER STANDARDS

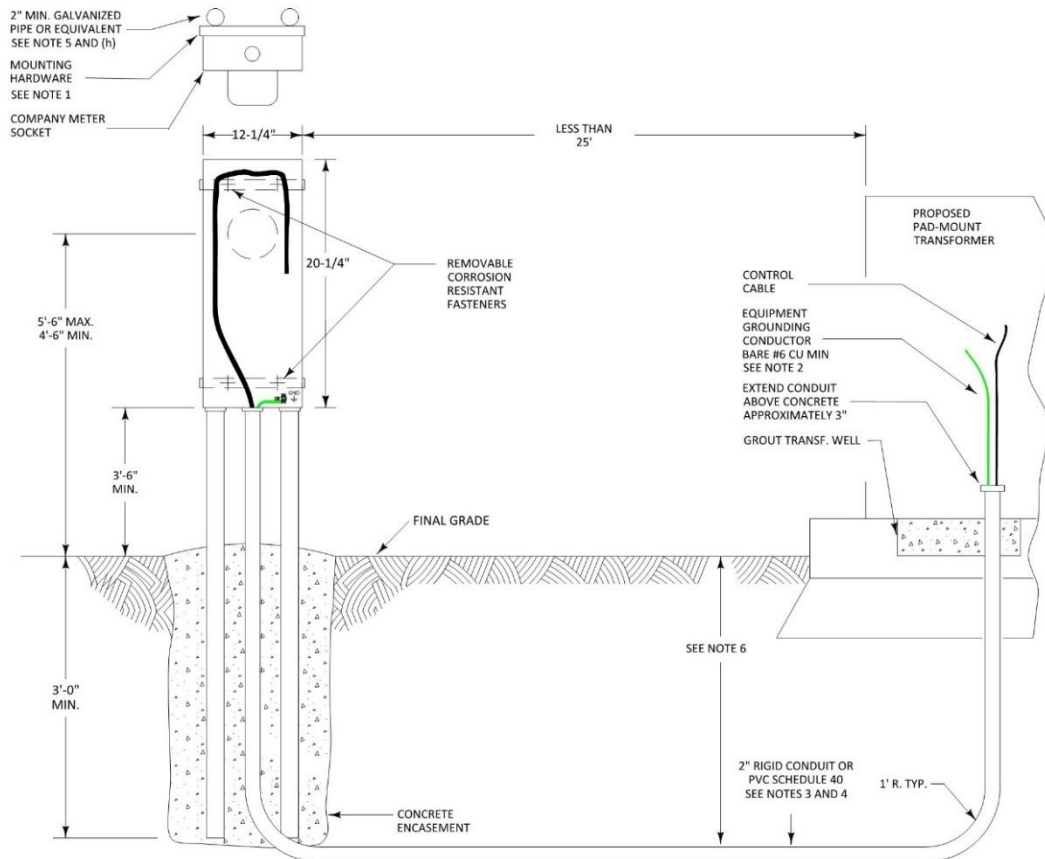

GENERAL CONDITION NOTES:

THE COMPANY SHALL BE RESPONSIBLE FOR:

- (a) FURNISHING DESIGN SHORT CIRCUIT VALUE IF REQUIRED.
- (b) FURNISHING THE METER SOCKET AND CONTROL CABLE TO CUSTOMER.
- (c) INSTALLING AND REMOVING THE METER.
- (d) THIS DESIGN IS FOR FREE STANDING METER SOCKET LOCATED ADJACENT TO A PAD-MOUNT TRANSFORMER.

THE CUSTOMER SHALL BE RESPONSIBLE FOR:

- (e) FURNISHING AND INSTALLING THE METER STRUCTURE AS SHOWN ABOVE.
- (f) FURNISHING AND INSTALLING THE METER CONDUIT TO THE PAD-MOUNT TRANSFORMER.
- (g) PULL CONTROL CABLE AND EQUIPMENT GROUND IN CONDUIT FROM METER SOCKET TO PAD MOUNT TRANSFORMER. IF CONTROL CABLE IS NOT AVAILABLE, A PULL STRING WILL BE PROVIDED BY THE CUSTOMER.
- (h) INSTALLING METER SOCKET AT LOCATION USING REMOVABLE CORROSION RESISTANT FASTENERS.
- (i) INSTALLING GALVANIZED SUPPORT PIPES WHICH SHALL BE CAPPED OR FILLED WITH CONCRETE.

GENERAL CONSTRUCTION NOTES:

- 1. USE TWO 12 GAUGE 1-5/8" x 1-5/8" CONTINUOUS SLOT HOT DIPPED GALVANIZED CHANNEL (e.g., UNISTRUT) COMPLETE WITH 1-1/4" x 5/16" DIA. 13 THD SPRING NUT (2 PER CHANNEL), 5/16" HEX NUT, AND LOCK WASHER SECURELY MOUNTED TO SUPPORT POST.
- 2. THE METER SOCKET SHALL BE GROUNDED. THE METER SOCKET SHALL BE BONDED THROUGH A SEPARATE EQUIPMENT- GROUNDING CONDUCTOR CONNECTED TO THE GROUNDED SERVICE CONDUCTOR.

GENERAL CONSTRUCTION NOTES CONTINUED:

- 3. IF THE CUSTOMER PERFORMS THE TRENCHING, THE TRENCH IS TO EXTEND NO CLOSER TO THE POWER COMPANY'S TRANSFORMER OR PEDESTAL THAN A DISTANCE SPECIFIED BY THE POWER COMPANY. CUSTOMER TO DETERMINE LOCATION OF ALL UTILITIES BEFORE TRENCHING.
- 4. SCHEDULE 80 RIGID CONDUIT REQUIRED FOR DRIVEWAYS AND PARKING LOTS.
- 5. EQUIVALENT MUST BE PREAPPROVED BY METER SERVICES.
- 6. BURIAL DEPTH IS THE DISTANCE BETWEEN FINAL GRADE AND THE TOP OF THE BURIED CABLE OR CONDUIT. THE POWER COMPANY (AEP) SHALL SPECIFY THE REQUIRED BURIAL DEPTH PER OPERATING COMPANY AS PRESCRIBED IN THE PROCEEDING LIST.

COMPANY	BURIAL DEPTH
APCO	= REQUIRES A BURIAL DEPTH OF 30"
KYPCO	= REQUIRES A BURIAL DEPTH OF 30"
I&M	= REQUIRES A BURIAL DEPTH OF 30"
OHIO	= REQUIRES A BURIAL DEPTH OF 30"
TEXAS	= REQUIRES A BURIAL DEPTH OF 36"
PSO	= REQUIRES A BURIAL DEPTH OF 36"
SWEPSCO	= REQUIRES A BURIAL DEPTH OF 36"

AND/OR CONFORM TO ANY OR ALL AUTHORITY HAVING JURISDICTION. THE POWER COMPANY (AEP) HAS PRESCRIBED THE BURIAL DEPTH SHALL NOT BE LESS THAN STATED DEPTH ON THE PRECEDING LIST UNLESS IMPOSSIBLE TO BE ACHIEVED OR IS SUPERSEDED BY LOCAL AUTHORITY HAVING JURISDICTION. IF THE DEPTH IS IMPOSSIBLE TO ACHIEVED AEP'S VERIFICATION WILL BE NEEDED. HOWEVER, BURIAL DEPTH NOT TO BE LESS THAN WHAT IS STATED IN THE NATIONAL ELECTRICAL CODE'S ARTICLES AND ARTICLE 300: 300.3(B) (1), 300.3 (C) (1) (2), TABLE 300.5, AND TABLE 300.50.

FOR FURTHER INFORMATION ON UTILITY REQUIREMENTS PLEASE CONTACT YOUR LOCAL AEP OPERATING COMPANY.

METER INSTALLATION  
FROM PAD-MOUNT TRANSFORMER USING BUSHING - TYPE CTS

AMERICAN ELECTRIC POWER COMPANY  
METER STANDARDS

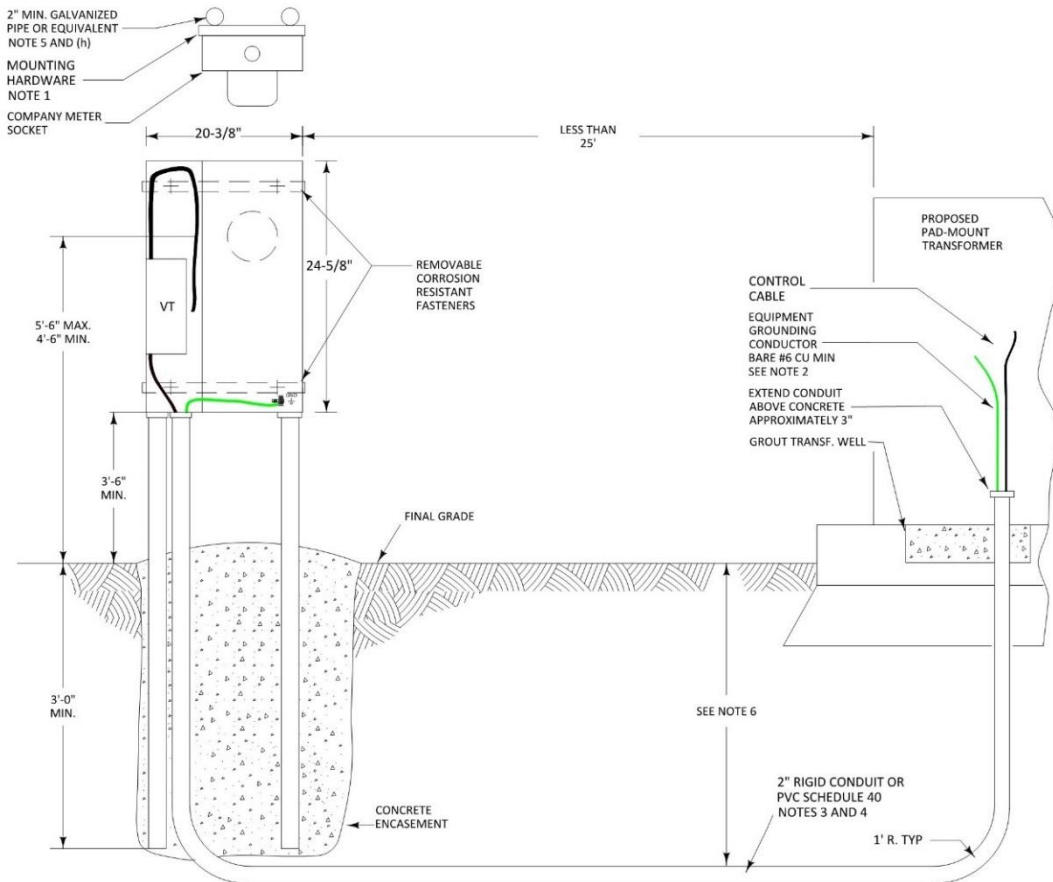

**GENERAL CONDITION NOTES:**

THE COMPANY WILL BE RESPONSIBLE FOR:

- (a) FURNISHING DESIGN SHORT CIRCUIT VALUE IF REQUIRED.
- (b) FURNISHING THE METER SOCKET AND CONTROL CABLE TO CUSTOMER.
- (c) INSTALLING AND REMOVING THE METER.

THE CUSTOMER WILL BE RESPONSIBLE FOR:

- (d) FURNISHING AND INSTALLING THE METER STRUCTURE AS SHOWN ABOVE.
- (e) FURNISHING AND INSTALLING THE METER CONDUIT TO THE PAD-MOUNT TRANSFORMER.
- (f) PULL CONTROL CABLE AND EQUIPMENT GROUND IN CONDUIT FROM METER SOCKET TO PAD MOUNT TRANSFORMER. IF CONTROL CABLE IS NOT AVAILABLE, A PULL STRING WILL BE PROVIDED BY THE CUSTOMER.
- (g) INSTALLING METER SOCKET AT LOCATION USING REMOVABLE CORROSION RESISTANT FASTENERS.
- (h) INSTALLING GALVANIZED SUPPORT PIPES WHICH SHALL BE CAPPED OR FILLED WITH CONCRETE.
- (i) THIS DESIGN IS FOR FREE STANDING METER SOCKET LOCATED ADJACENT TO A PAD-MOUNT TRANSFORMER.

**GENERAL CONSTRUCTION NOTES:**

- 1. USE TWO 12 GAUGE 1-5/8" x 1-5/8" CONTINUOUS SLOT HOT-DIPPED GALVANIZED CHANNEL (e.g., UNISTRUT) COMPLETE WITH 1-1/4" x 5/16" DIA. 13 THD SPRING NUT (2 PER CHANNEL), 5/16" HEX NUT, AND LOCK WASHER SECURELY MOUNTED TO SUPPORT POST.

- 2. THE METER SOCKET SHALL BE GROUNDED. THE METER SOCKET SHALL BE BONDED THROUGH A SEPARATE EQUIPMENT-GROUNDING CONDUCTOR CONNECTED TO THE GROUNDED SERVICE CONDUCTOR.
- 3. IF THE CUSTOMER DOES THE TRENCHING, THE TRENCH IS TO EXTEND NO CLOSER TO THE POWER COMPANY'S TRANSFORMER OR PEDESTAL THAN A DISTANCE SPECIFIED BY THE POWER COMPANY. CUSTOMER TO DETERMINE LOCATION OF ALL UTILITIES BEFORE TRENCHING.
- 4. SCHEDULE 80 RIGID CONDUIT REQUIRED FOR DRIVEWAYS AND PARKING LOTS.
- 5. EQUIVALENT MUST BE PRE-APPROVED BY METER SERVICES.
- 6. BURIAL DEPTH IS THE DISTANCE BETWEEN FINAL GRADE AND THE TOP OF THE BURIED CABLE OR CONDUIT. THE POWER COMPANY (AEP) SHALL SPECIFY THE REQUIRED BURIAL DEPTH PER OPERATING COMPANY AS PRESCRIBED IN THE PROCEEDING LIST:

COMPANY	BURIAL DEPTH
APCO	= REQUIRES A BURIAL DEPTH OF 30"
KYPCO	= REQUIRES A BURIAL DEPTH OF 30"
I&M	= REQUIRES A BURIAL DEPTH OF 30"
OHIO	= REQUIRES A BURIAL DEPTH OF 30"
TEXAS	= REQUIRES A BURIAL DEPTH OF 36"
PSO	= REQUIRES A BURIAL DEPTH OF 36"
SWEPSCO	= REQUIRES A BURIAL DEPTH OF 36"

AND/OR CONFORM TO ANY OR ALL AUTHORITY HAVING JURISDICTION. THE POWER COMPANY (AEP) HAS PRESCRIBED THE BURIAL DEPTH SHALL NOT BE LESS THAN STATED DEPTH ON THE PRECEDING LIST UNLESS IMPOSSIBLE TO BE ACHIEVED OR IS SUPERSEDED BY LOCAL AUTHORITY HAVING JURISDICTION. IF THE DEPTH IS IMPOSSIBLE TO ACHIEVED AEP'S VERIFICATION WILL BE NEEDED. HOWEVER, BURIAL DEPTH NOT TO BE LESS THAN WHAT IS STATED IN THE NATIONAL ELECTRICAL CODE'S ARTICLES AND ARTICLE 300: 300.3(B) (1), 300.3 (C) (1) (2), TABLE 300.5, AND TABLE 300.50.

**FOR FURTHER INFORMATION ON UTILITY REQUIREMENTS PLEASE CONTACT YOUR LOCAL AEP OPERATING COMPANY.**

METER INSTALLATION FROM PAD-MOUNT TRANSFORMER  
TO METER ENCLOSURE W/ VT PACK 480V

AMERICAN ELECTRIC POWER COMPANY  
DISTRIBUTION STANDARDS

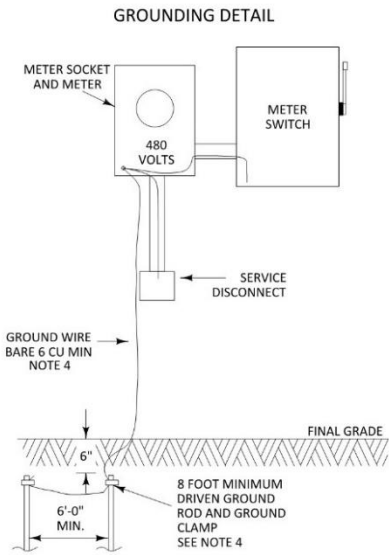
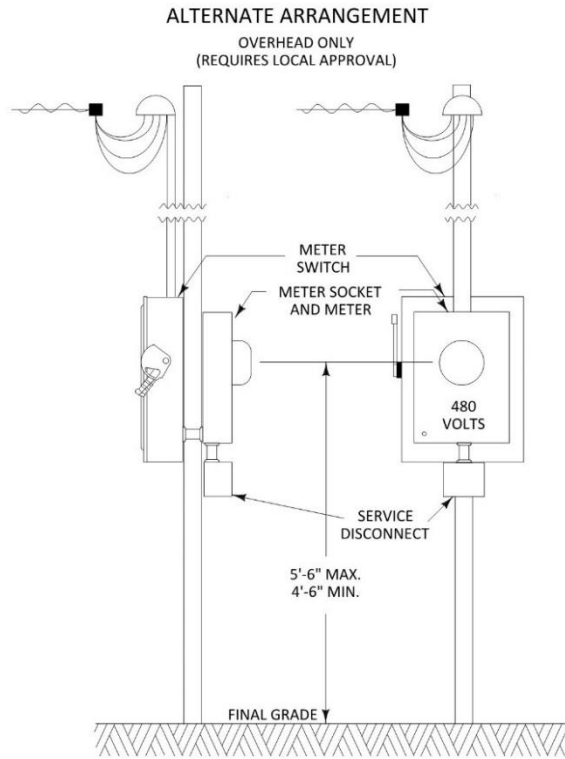
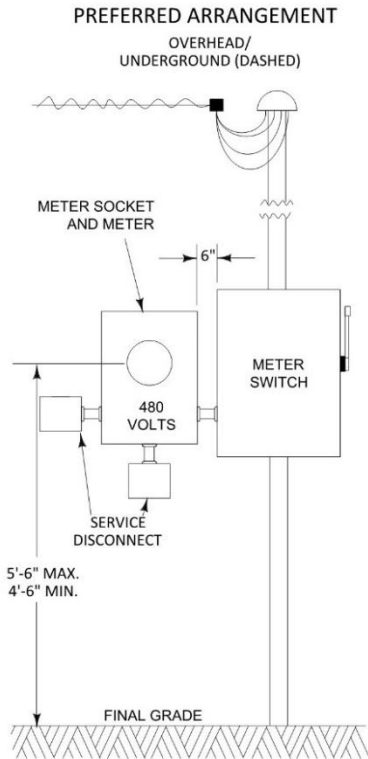

NOTES:

1. THE FOLLOWING COMPANIES DO NOT ALLOW 480 VOLT SELF-CONTAINED METERING: AEP OHIO, IMPCO, APCO, KYPCO, KINGSPORT POWER  
  
THE FOLLOWING COMPANIES DO ALLOW 480 VOLT SELF-CONTAINED METERING AT 200-AMP SERVICE OR LESS: AEP TEXAS, PSO, SWEPCO  
  
FOR 480-VOLT SELF-CONTAINED METERING AT GREATER THAN 200-AMP SERVICE, TRANSFORMER-RATED SERVICE IS REQUIRED ACROSS ALL OPERATING COMPANIES.
2. METER SWITCH SUPPLIED AND INSTALLED BY CUSTOMER. METER SWITCH AND METER ENCLOSURE TO BE LOCKED AND SEALED UNDER THE EXCLUSIVE CONTROL OF THE COMPANY.
3. METER SOCKET SECURELY MOUNTED IN PLUMB POSITION BY CUSTOMER. SERVICE ATTACHMENT AND METERING INSTALLATION LOCATION TO BE SPECIFIED BY POWER COMPANY.
4. CUSTOMER GROUNDING SHALL BE IN ACCORDANCE WITH NEC AND LOCAL REGULATIONS. IN ARKANSAS, OKLAHOMA, LOUISIANA AND TEXAS, THE GROUND WIRE SHALL BE CONNECTED IN THE METER SOCKET. THE CUSTOMER SHALL HAVE A MINIMUM OF 2 DRIVEN GROUND RODS AT LEAST 6 FEET APART, OR ELSE MEET NEC REQUIREMENTS.
5. THE CUSTOMER'S SERVICE DISCONNECT SHALL BE GROUNDED.
6. OVERHEAD SERVICE ATTACHMENT HEIGHT PER FIGURE M.S.\_F005.
7. FOR UNDERGROUND SERVICE INSTALLATIONS, REFER TO FIGURE M.S.\_F008.
8. METER SWITCH MUST BE OPEN WHEN INSTALLING OR REMOVING THE METER.
9. METER SWITCH SHALL BE NON-FUSED, WITH A MIN RATING OF 200 AMPS, 600 VOLTS, UL LISTED, TYPE 3R FOR NON-CORROSIVE, TYPE 4X FOR CORROSIVE ENVIRONMENTS.
10. MORE INFORMATION CAN BE FOUND IN SECTION 8.5 OF THIS DOCUMENT.
11. METER ENCLOSURE MUST HAVE 'FULLY RATED' BYPASS FOR COMMERCIAL INSTALLATIONS
12. ANTI-OXIDANT COMPOUNDS SHALL NOT BE USED ON METER SOCKET BLADES OR METER BASE JAWS. ANTI-OXIDANT COMPOUNDS CAN BE USED ON ALUMINUM CONDUCTORS AND METER BASE TERMINAL PER LOCAL AHI (AUTHORITY HAVING JURISDICTION).

FOR FURTHER INFORMATION ON UTILITY REQUIREMENTS PLEASE CONTACT YOUR LOCAL AEP OPERATING COMPANY.

480V SELF CONTAINED METERING  
SERVICES  
(200A MAX)

AMERICAN ELECTRIC POWER COMPANY  
METER STANDARDS

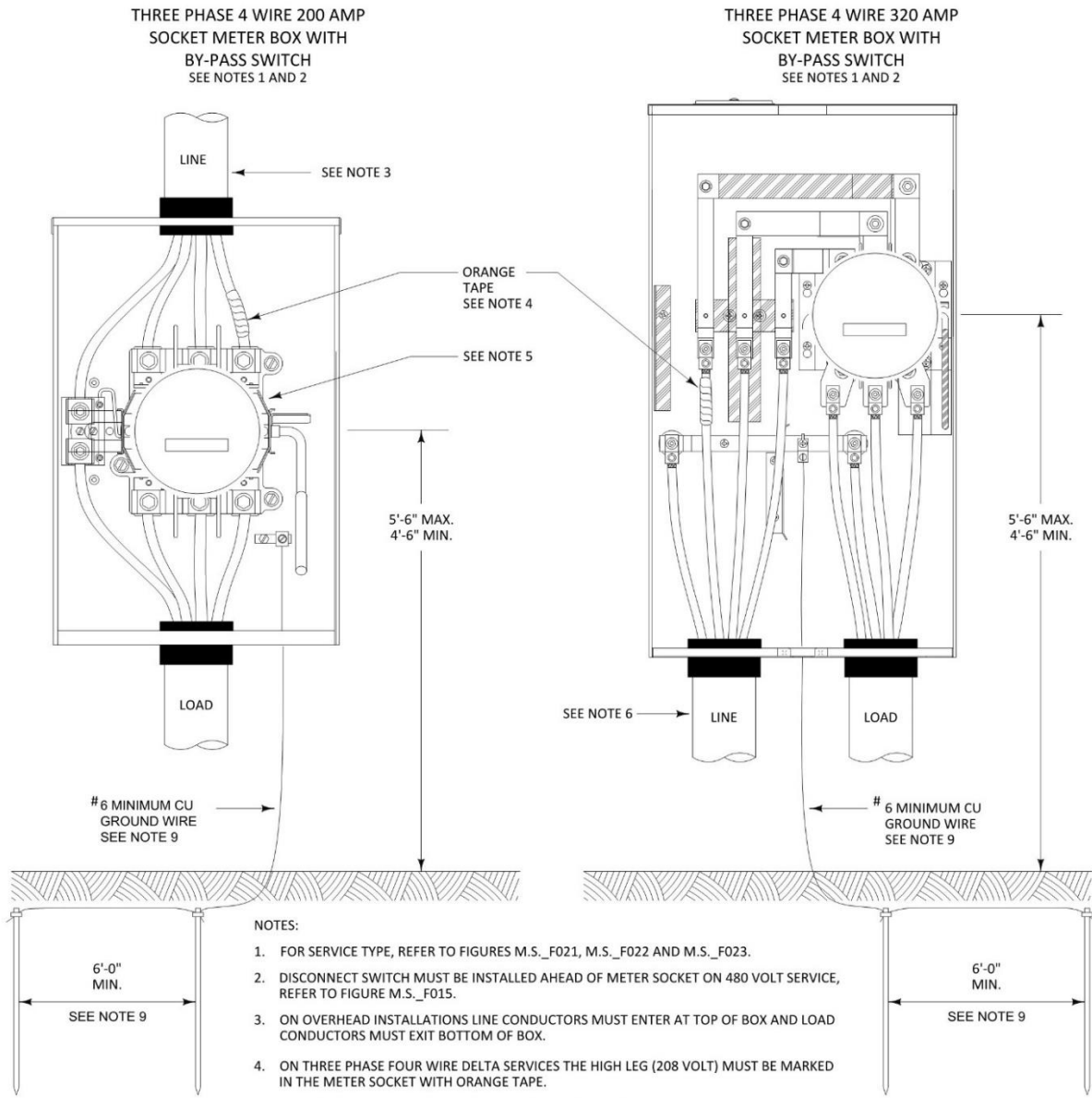

- NOTES:
1. FOR SERVICE TYPE, REFER TO FIGURES M.S.\_F021, M.S.\_F022 AND M.S.\_F023.
  2. DISCONNECT SWITCH MUST BE INSTALLED AHEAD OF METER SOCKET ON 480 VOLT SERVICE, REFER TO FIGURE M.S.\_F015.
  3. ON OVERHEAD INSTALLATIONS LINE CONDUCTORS MUST ENTER AT TOP OF BOX AND LOAD CONDUCTORS MUST EXIT BOTTOM OF BOX.
  4. ON THREE PHASE FOUR WIRE DELTA SERVICES THE HIGH LEG (208 VOLT) MUST BE MARKED IN THE METER SOCKET WITH ORANGE TAPE.
  5. DO NOT REMOVE PLASTIC BARRIER COVERING LINE OR LOAD METER TERMINALS.
  6. ON UNDERGROUND INSTALLATIONS LINE CONDUCTORS MUST ENTER LEFT BOTTOM AND LOAD WIRES EXIT BOTTOM RIGHT.
  7. MUST USE MANUFACTURER-PROVIDED KNOCKOUTS.
  8. METER ENCLOSURE MUST HAVE 'FULLY-RATED BYPASS' FOR COMMERCIAL INSTALLATIONS.
  9. CUSTOMER IS TO SIZE GROUND WIRE ACCORDING TO NEC REQUIREMENTS. THE CUSTOMER SHALL HAVE A MINIMUM OF 2 DRIVEN GROUND RODS AT LEAST 6 FEET APART OR PER NEC.
  10. ANTI-OXIDANT COMPOUNDS **SHALL NOT BE USED ON METER SOCKET BLADES OR METER BASE JAWS.** ANTI-OXIDANT COMPOUNDS CAN BE USED ON ALUMINUM CONDUCTORS AND METER BASE TERMINAL PER LOCAL AHJ (AUTHORITY HAVING JURISDICTION).

FOR FURTHER INFORMATION ON UTILITY REQUIREMENTS PLEASE CONTACT YOUR LOCAL AEP OPERATING COMPANY.

THREE PHASE SELF-CONTAINED METER SOCKET

AMERICAN ELECTRIC POWER COMPANY  
METER STANDARDS

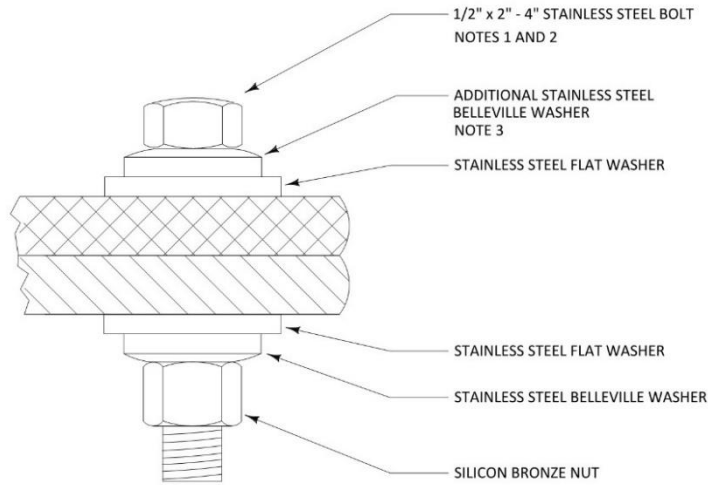

TABLE 1

INHIBITOR COMPOUND FOR FLAT SURFACE JOINTS AND BOLT LUBRICATION	
CONNECTION (PLATED & NON PLATED)	INDOOR AND OUTDOOR
CU TO CU	NO-OX-ID GRADE A
CU TO AL	ALCOA 2EJC
AL TO AL	

NOTES:

1. THE BOLT ASSEMBLY SHOWN HERE CAN BE USED TO BOLT ANY COMBINATION OF MATERIALS (ALL COPPER, ALL ALUMINUM OR ANY COMBINATION OF COPPER AND ALUMINUM)
2. ASSEMBLY INSTRUCTIONS:
  - (a) NON-PLATED SURFACES - THOROUGHLY CLEAN FLAT CONTACT SURFACES WITH A STAINLESS STEEL WIRE BRUSH TO REMOVE OXIDES, GREASE AND DIRT. COAT CONTACT SURFACES IMMEDIATELY WITH AN APPROVED CORROSION INHIBITING COMPOUND (TABLE 1).  
 PLATED SURFACES - THOROUGHLY CLEAN FLAT CONTACT SURFACES WITH AN APPROVED SOLVENT (DO NOT WIRE BRUSH UNLESS THE PLATING HAS BECOME CORRODED) TO REMOVE GREASE AND DIRT. COAT CONTACT SURFACES IMMEDIATELY WITH A CORROSION INHIBITING COMPOUND (TABLE 1). THIS PROCEDURE CAN ALSO BE USED ON SILVER PLATED COMPONENTS OF MANUFACTURER SUPPLIED EQUIPMENT UNLESS OTHERWISE DIRECTED BY THE MANUFACTURER'S INSTALLATION INSTRUCTIONS.
  - (b) CONNECTIONS SHOULD BE TIGHTENED TO 360 IN.-LBS. (30 FT.-LBS.).
  - (c) WIPE OFF THE EXCESS CORROSION INHIBITING COMPOUND, HOWEVER A BEAD OF COMPOUND IS DESIRABLE AROUND THE SURFACE EDGES TO ACT AS A SEALANT.
3. IF MATERIAL TO BE BOLTED EXCEEDS 3 INCHES IN THICKNESS A BELLEVILLE WASHER MUST BE USED UNDER THE BOLT HEAD.
4. WHEN THE ABOVE ASSEMBLY IS NOT AVAILABLE AND THE ASSEMBLY CANNOT BE MADE UP FROM INDIVIDUAL PARTS IN STOCK THE FOLLOWING BOLTS CAN BE USED:
  - (a) WHEN BOLTING ALUMINUM TO ALUMINUM AN ALUMINUM BOLT AND NUT CAN BE USED. AN ALUMINUM FLAT WASHER SHOULD BE USED UNDER BOTH THE BOLT HEAD AND NUT. TIGHTEN INHIBITOR LUBRICATED BOLT TO 300 IN.-LBS. (25 FT.-LBS.).
  - (b) WHEN BOLTING COPPER TO COPPER A SILICON BRONZE BOLT AND NUT CAN BE USED. A SILICON BRONZE FLAT WASHER SHOULD BE USED UNDER BOTH THE BOLT HEAD AND THE NUT. CONNECTIONS SHOULD BE TIGHTENED TO 360 IN.-LBS. (30 FT.-LBS.).
  - (c) WHEN BOLTING COPPER TO ALUMINUM A GALVANIZED STEEL BOLT, NUT, FLAT WASHERS AND STAINLESS STEEL BELLEVILLE WASHER CAN BE USED. CONNECTIONS SHOULD BE TIGHTENED TO 360 IN.-LBS. (30 FT.-LBS.).

FOR FURTHER INFORMATION ON UTILITY REQUIREMENTS PLEASE CONTACT YOUR LOCAL AEP OPERATING COMPANY.

BOLTED CONNECTOR ASSEMBLIES

AMERICAN ELECTRIC POWER COMPANY  
METER STANDARDS

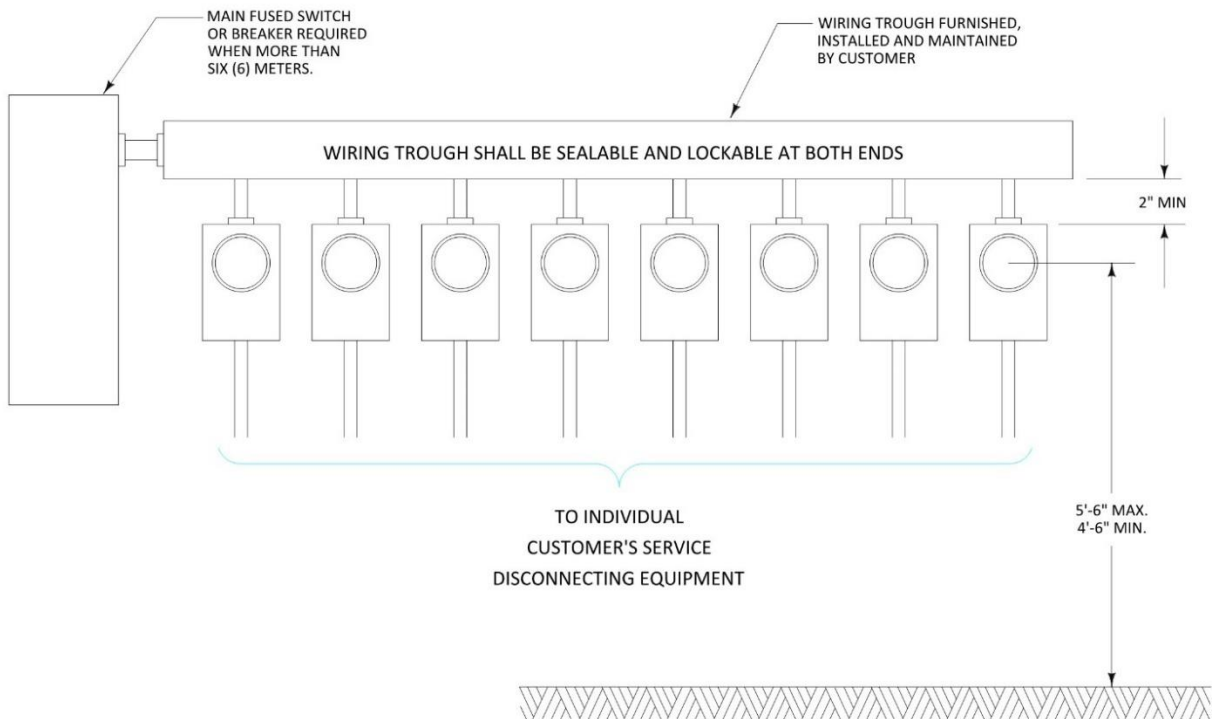

NOTES:

1. CUSTOMER MUST CONSULT WITH COMPANY FOR POINT OF ATTACHMENT OF SERVICE LATERAL OR DROP, METERING LOCATION, AND PROPOSED SERVICE ENTRANCE FACILITIES PRIOR TO PROCEEDING WITH THIS INSTALLATION.
2. ALL CUSTOMER WORK MUST BE COMPLETED AND INSPECTIONS OBTAINED BEFORE COMPANY WILL PROVIDE SERVICE.
3. CUSTOMER SHALL BE RESPONSIBLE FOR FURNISHING, INSTALLING AND CONNECTING ALL SERVICE ENTRANCE WIRING FROM TERMINAL BOX WHERE REQUIRED OR MAIN DISCONNECT TO METER SOCKETS AND ALSO BE RESPONSIBLE FOR ENSURING THAT TERMINAL BOX OR MAIN DISCONNECT HAS PROPER NUMBER, SIZE AND TYPE OF TERMINALS TO ACCEPT COMPANY SERVICE LATERAL.
4. CUSTOMER WILL INSTALL ALL METER SOCKETS AND CONNECT ALL CONDUCTORS IN METER SOCKET.
5. COMPANY WILL FURNISH AND INSTALL METERS.
6. METERED CONDUCTORS SHALL NOT BE INSTALLED IN WIRING TROUGH(S).
7. CUSTOMER MAY INSTALL METER STACK OR METER TROUGH TYPE EQUIPMENT SUBJECT TO COMPANY APPROVAL.
8. WIRING TROUGH(S), MAIN SERVICE DISCONNECT OR TERMINAL BOX SHALL BE SEALABLE, LOCKABLE AND SHALL ALSO BE WEATHERPROOF WHEN INSTALLED OUTDOORS.
9. LINE SIDE, DISCONNECT REQUIRED FOR EACH SOCKET ON 480 VOLT INSTALLATIONS, REFER TO FIGURE M.S.\_F015.
10. WHERE MORE THAN ONE METER IS TO BE INSTALLED AT A GIVEN LOCATION, EACH METER CIRCUIT SHALL BE MARKED TO INDICATE EXACTLY THE CUSTOMER SERVED. IN APARTMENT HOUSES, THE MARKINGS MUST BE THE SAME AS THE APARTMENT IDENTIFICATIONS, SUCH AS NUMBER OR LETTERS. MARKINGS SUCH AS "UPPER NORTH", "LEFT FRONT", "REAR", ETC., ARE NOT ACCEPTABLE. TENANT'S NAMES SHALL NOT BE USED AS MEANS OF IDENTIFICATION. IDENTIFICATION SHALL BE ON THE SERVICE SWITCH BOX WITH PAINT OR ON THE METER ENCLOSURE OR SOCKET BASE (NOT COVER) WITH PAINT OR METAL LETTER.
11. CUSTOMER GROUNDING SHALL BE IN ACCORDANCE WITH NEC.
12. AEP TEXAS - THE MAXIMUM NUMBER OF METERS INSTALLATION IS 12 UNLESS PRIOR AGREEMENT HAS BEEN REACHED VIA CONSULTATION WITH THE COMPANY.
13. ANTI-OXIDANT COMPOUNDS **SHALL NOT BE USED ON METER SOCKET BLADES OR METER BASE JAWS.**  
ANTI-OXIDANT COMPOUNDS CAN BE USED ON ALUMINUM CONDUCTORS AND METER BASE TERMINAL PER LOCAL AHJ (AUTHORITY HAVING JURISDICTION).
14. PLEASE CHECK WITH YOUR LOCAL AHJ (AUTHORITY HAVING JURISDICTION) TO VERIFY WHETHER YOU ARE REQUIRED TO INSTALL A FULL SERVICE SURGE PROTECTION PER NEC 2020.

FOR FURTHER INFORMATION ON UTILITY REQUIREMENTS PLEASE CONTACT YOUR LOCAL AEP OPERATING COMPANY.

MULTIPLE METER INSTALLATION

AMERICAN ELECTRIC POWER COMPANY  
METER STANDARDS

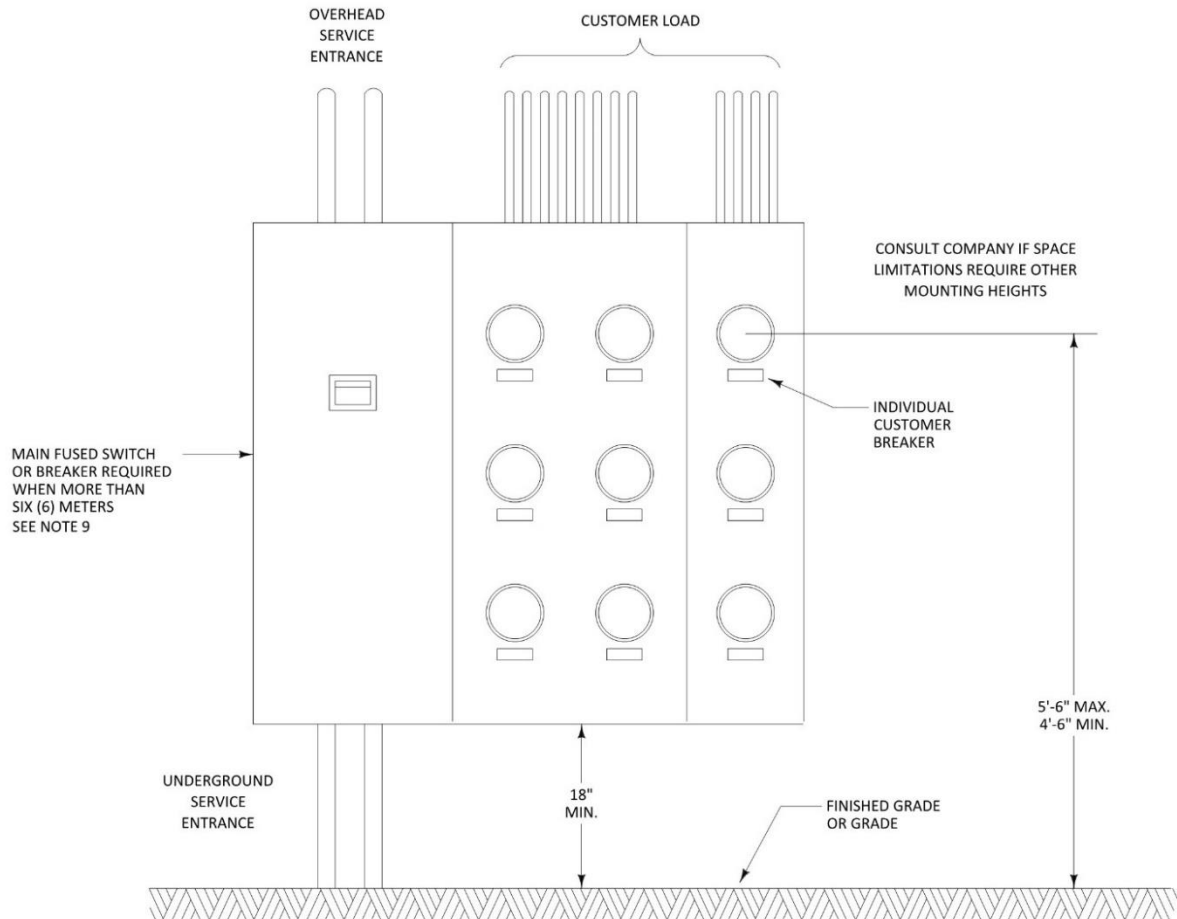

NOTES:

1. CUSTOMER MUST CONSULT WITH COMPANY FOR POINT OF ATTACHMENT OF SERVICE LATERAL OR DROP, METERING LOCATION, AND PROPOSED SERVICE ENTRANCE FACILITIES PRIOR TO PROCEEDING WITH THIS INSTALLATION.
2. ALL CUSTOMER WORK MUST BE COMPLETED AND INSPECTIONS OBTAINED BEFORE COMPANY WILL PROVIDE SERVICE.
3. CUSTOMER SHALL BE RESPONSIBLE FOR FURNISHING, INSTALLING AND CONNECTING ALL SERVICE ENTRANCE WIRING FROM TERMINAL BOX OR MAIN DISCONNECT TO METER SOCKETS AND ALSO BE RESPONSIBLE FOR INSURING THAT TERMINAL BOX OR MAIN DISCONNECT HAS PROPER NUMBER, SIZE AND TYPE OF TERMINALS TO ACCEPT COMPANY SERVICE LATERAL.
4. WHERE MORE THAN ONE METER IS TO BE INSTALLED AT A GIVEN LOCATION, EACH METER CIRCUIT SHALL BE MARKED TO INDICATE EXACTLY THE CUSTOMER SERVED. IN APARTMENT HOUSES, THE MARKINGS MUST BE THE SAME AS THE APARTMENT IDENTIFICATIONS, SUCH AS NUMBER OR LETTERS. MARKINGS SUCH AS "UPPER NORTH", "LEFT FRONT", "REAR", ETC., ARE NOT ACCEPTABLE. TENANT'S NAMES SHALL NOT BE USED AS MEANS OF IDENTIFICATION. IDENTIFICATION SHALL BE ON THE SERVICE SWITCH BOX WITH PAINT OR ON THE METER ENCLOSURE OR SOCKET BASE (NOT COVER) WITH PAINT OR METAL LETTER.
5. CUSTOMER GROUNDING SHALL BE IN ACCORDANCE WITH NATIONAL ELECTRICAL CODE. THE CUSTOMER SHALL HAVE A MINIMUM OF 2 DRIVEN GROUND RODS AT LEAST 6 FEET APART OR PER NEC REQUIREMENTS.
6. LINE SIDE, NONFUSED DISCONNECT REQUIRED FOR EACH SOCKET ON 480 VOLT INSTALLATIONS, REFER TO FIGURE M.S.\_F015.
7. ALL 320 AMP METER SOCKETS AND 200 AMP METER SOCKETS WITH FIVE OR SEVEN TERMINALS SHALL HAVE A JAW RELEASING, MANUALLY OPERATED, 100 % RATED BYPASS.
8. METER SOCKETS WILL BE RINGLESS AND HAVE A SAFETY SHIELD.
9. WIRE WAYS OR MAIN DISCONNECTS FOR UN-METERED CONDUCTORS SHALL HAVE PROVISIONS FOR BEING EFFECTIVELY SEALED OR LOCKED BY COMPANY PERSONNEL. LINE AND LOAD CONDUCTORS SHALL NOT PASS THROUGH OR BE MIXED IN THE SAME WIRE-WAY, TROUGH OR MAIN-LINE DISCONNECT.
10. AEP TEXAS - THE MAXIMUM NUMBER OF METERS INSTALLATION IS 12 UNLESS PRIOR AGREEMENT HAS BEEN REACHED VIA CONSULTATION WITH THE COMPANY.
11. **ANTI-OXIDANT COMPOUNDS SHALL NOT BE USED ON METER SOCKET BLADES OR METER BASE JAWS.**  
ANTI-OXIDANT COMPOUNDS CAN BE USED ON ALUMINUM CONDUCTORS AND METER BASE TERMINAL PER LOCAL AHJ (AUTHORITY HAVING JURISDICTION).
12. PLEASE CHECK WITH YOUR LOCAL AHJ (AUTHORITY HAVING JURISDICTION) TO VERIFY WHETHER YOU ARE REQUIRED TO INSTALL A FULL SERVICE SURGE PROTECTION PER NEC 2020.

FOR FURTHER INFORMATION ON UTILITY REQUIREMENTS PLEASE CONTACT YOUR LOCAL AEP OPERATING COMPANY.

PRE-ASSEMBLED MULTIPLE METER INSTALLATION

AMERICAN ELECTRIC POWER COMPANY  
METER STANDARDS

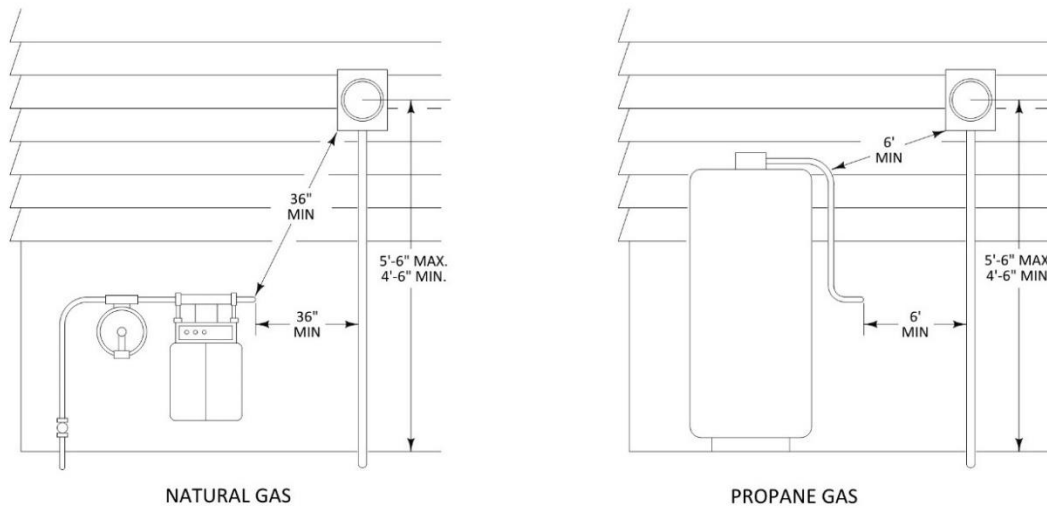

NATURAL GAS

PROPANE GAS

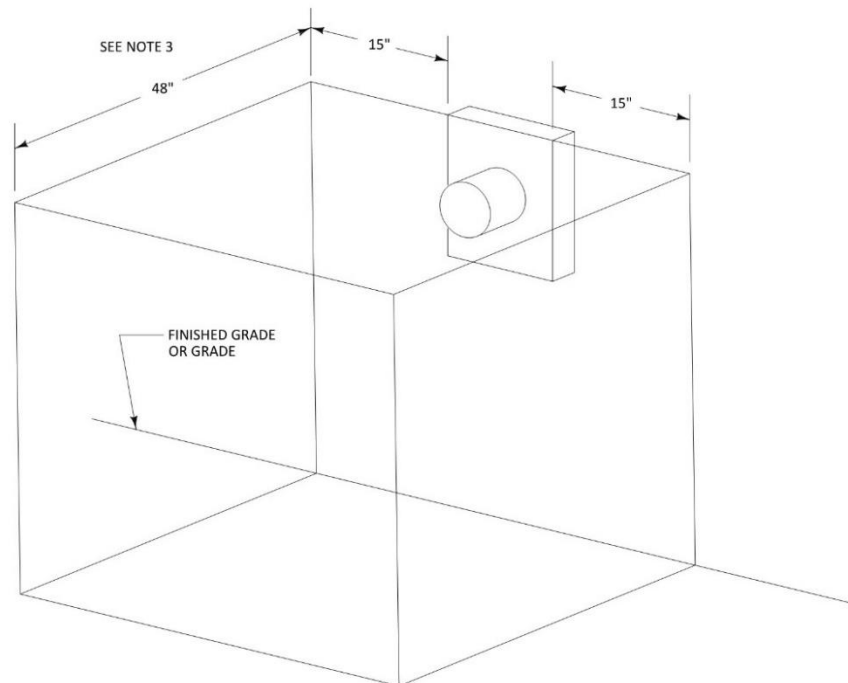

NOTES:

1. DIMENSIONS SHOWN ARE MINIMUMS. LOCAL INSPECTING AUTHORITY MAY REQUIRE GREATER SEPARATION.
2. SUFFICIENT ACCESS AND WORKING SPACE SHALL BE PROVIDED AND MAINTAINED ABOUT ALL METERING EQUIPMENT TO PERMIT READY AND SAFE OPERATION AND MAINTENANCE OF SUCH EQUIPMENT. THE DIMENSION OF THE WORKING SPACE IN THE DIRECTION OF ACCESS TO LIVE PARTS OPERATING AT 600 VOLTS OR LESS AND LIKELY TO REQUIRE EXAMINATION, ADJUSTMENT, SERVICING OR MAINTENANCE WHILE LIVE SHALL NOT BE LESS THAN 4 FEET, AND THE WORK SPACE SHALL NOT BE LESS THAN FIFTEEN (15") INCHES TO EITHER SIDE OF THE ELECTRIC EQUIPMENT. IN NO CASE SHALL HEADROOM BE LESS THAN 7 FEET. PLANTS, SHRUBS, AND TREES MUST NOT BE PLANTED IN THIS SPACE.
3. SEE NEC FOR VOLTAGES GREATER THAN 120V TO GROUND.

**FOR FURTHER INFORMATION ON UTILITY REQUIREMENTS PLEASE CONTACT YOUR LOCAL AEP OPERATING COMPANY.**

METER CLEARANCES

M.S.\_F020A – CT CABINET AND METER EQUIPMENT CLEARANCES GROUND-LEVEL INSTALLATION

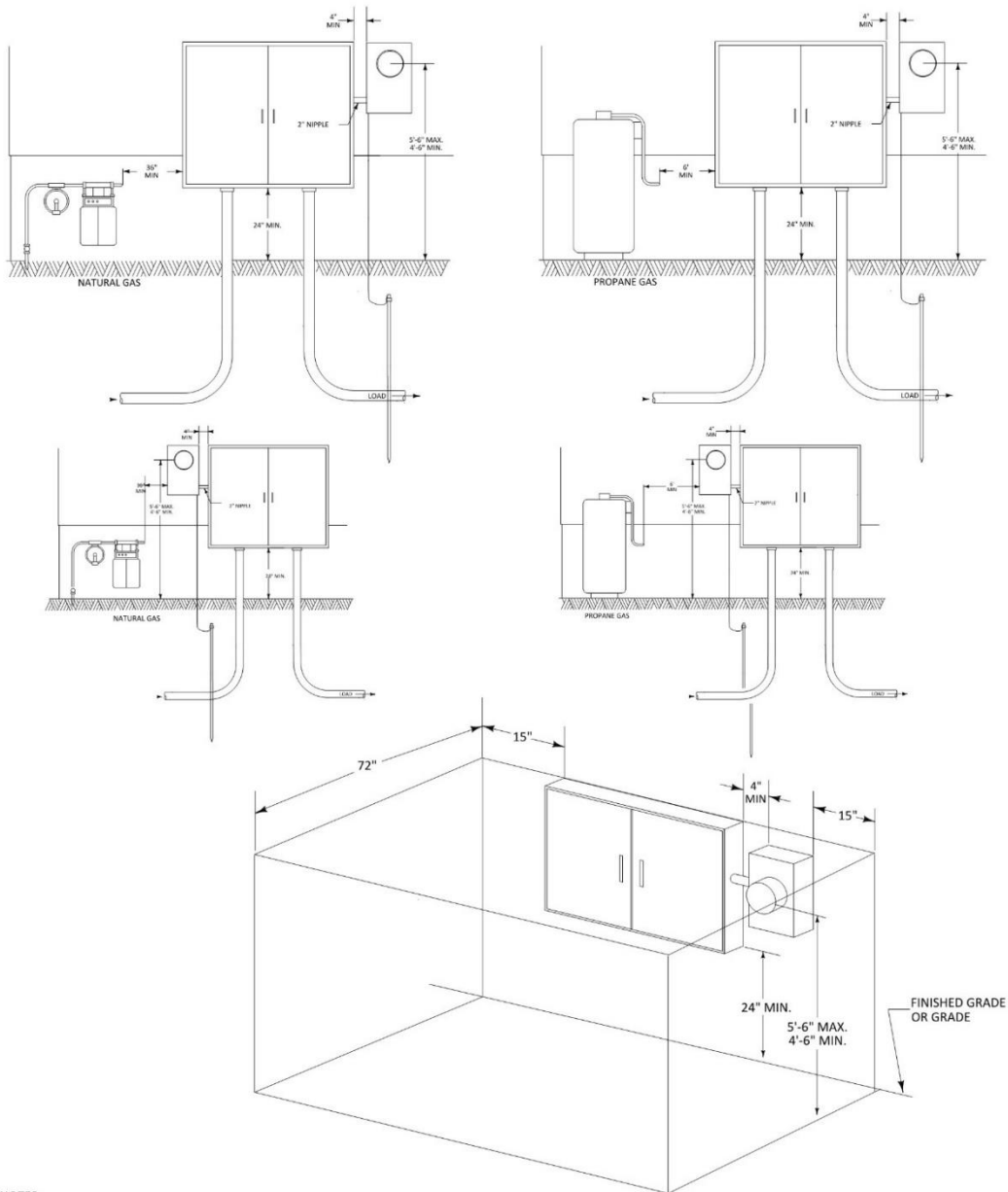

NOTES:

1. DIMENSIONS SHOWN ARE MINIMUMS. LOCAL INSPECTING AUTHORITY MAY REQUIRE GREATER SEPARATION.
2. SUFFICIENT ACCESS AND WORKING SPACE SHALL BE PROVIDED AND MAINTAINED ABOUT ALL METERING EQUIPMENT TO PERMIT READY AND SAFE OPERATION AND MAINTENANCE OF SUCH EQUIPMENT. THE DIMENSION OF THE WORKING SPACE IN THE DIRECTION OF ACCESS TO LIVE PARTS OPERATING AT 600 VOLTS OR LESS AND LIKELY TO REQUIRE EXAMINATION, ADJUSTMENT, SERVICING OR MAINTENANCE WHILE LIVE SHALL NOT BE LESS THAN 6 FEET, AND THE WORK SPACE SHALL NOT BE LESS THAN FIFTEEN (15") INCHES TO EITHER SIDE OF THE ELECTRIC EQUIPMENT. AS LONG AS DOORS CAN OPEN ALL THE WAY. THE 6' CLEARANCE IN FRONT OF THE CT CABINET SHALL BE REQUIRED TO ALLOW THE DOORS TO OPEN WITHOUT ANY OBSTRUCTIONS OR BARRIERS. IN NO CASE SHALL HEADROOM BE LESS THAN 7 FEET. PLANTS, SHRUBS, AND TREES MUST NOT BE PLANTED IN THIS SPACE.
3. SEE NEC FOR VOLTAGES GREATER THAN 120V TO GROUND.

FOR FURTHER INFORMATION ON UTILITY REQUIREMENTS PLEASE CONTACT YOUR LOCAL AEP OPERATING COMPANY.

CT CABINET AND METER EQUIPMENT CLEARANCES  
GROUND LEVEL INSTALLATION

**M.S.\_F021A – TYPICAL OVERHEAD CT CABINET AND METER EQUIPMENT CATWALK INSTALLATION WALL MOUNT ABOVE FLOOD LEVEL WITH PLATFORM**

**AMERICAN ELECTRIC POWER COMPANY  
METER STANDARDS**

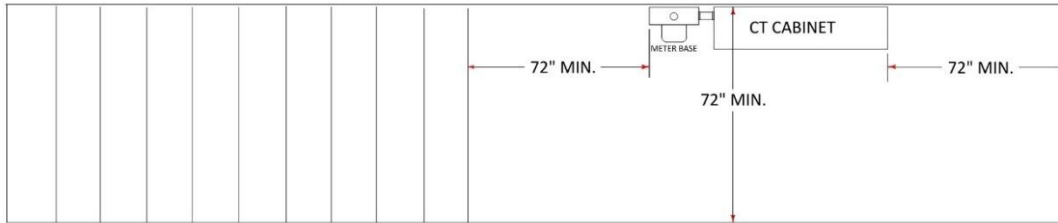

**TOP VIEW**

PLATFORM SHALL BE AN ENGINEERED PLATFORM AND MEET ALL AEP'S SPECIFICATIONS, AND SAFELY WITHSTAND A 1000 POUND MIN WORKING LOAD.  
MINIMUM VERTICAL CLEARANCE SHALL BE AS REQUIRED BY AEP SPECIFICATION STATED IN THIS GUIDE (SEE ABOVE FIGURE), BUT IN NO CASE SHALL THE PLATFORM BE LESS THAN 12.0' AT LOWEST POINT OF SERVICE DROP.

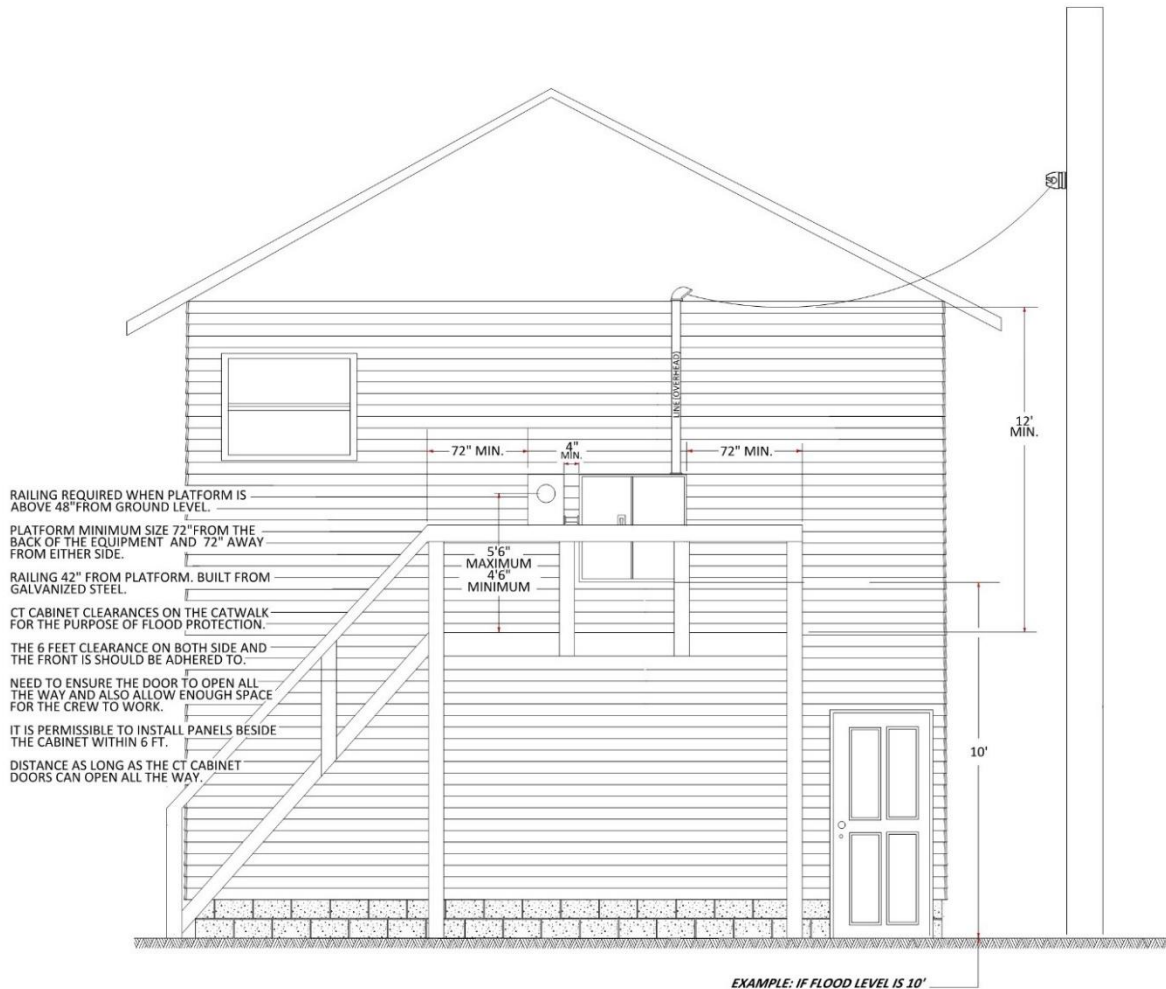

**FOR FURTHER INFORMATION ON UTILITY REQUIREMENTS PLEASE CONTACT YOUR LOCAL AEP OPERATING COMPANY.**

**TYPICAL OVERHEAD CT CABINET AND METER EQUIPMENT  
CATWALK INSTALLATION WALL MOUNT ABOVE FLOOD LEVEL WITH PLATFORM**

M.S.\_F021B – TYPICAL OVERHEAD METER EQUIPMENT SELF-STANDING PLATFORM INSTALLATION POLE MOUNT ABOVE FLOOD LEVEL

AMERICAN ELECTRIC POWER COMPANY  
METER STANDARDS

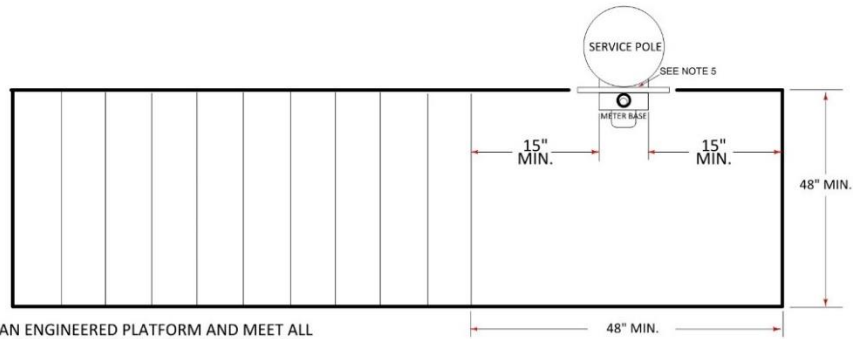

**TOP VIEW**

PLATFORM SHALL BE AN ENGINEERED PLATFORM AND MEET ALL AEP'S SPECIFICATIONS, AND SAFELY WITHSTAND A 1000 POUND MIN WORKING LOAD.  
MINIMUM VERTICAL CLEARANCE SHALL BE AS REQUIRED BY AEP SPECIFICATION STATED IN THIS GUIDE (SEE ABOVE FIGURE), BUT IN NO CASE SHALL THE PLATFORM BE LESS THAN 12.0' AT LOWEST POINT OF SERVICE DROP.

1. RAILING REQUIRED WHEN PLATFORM IS ABOVE 48" FROM GROUND LEVEL WITH A RAILING HIGH OF 42" FROM PLATFORM AND STAIRS.
2. SELF STANDING PLATFORM SHALL NOT EXCEED 8 FEET TO THE DECK.
3. BUILT FROM AEP APPROVED MATERIALS, PER OPERATING COMPANY.
4. METER BASE CLEARANCES ON THE PLATFORM FOR THE PURPOSE OF FLOOD PROTECTION MUST MAINTAIN MINIMUM 15" CLEARANCE ON BOTH SIDES. 48" DEPTH OF THE PLATFORM MUST BE MAINTAINED TO INSURE SAFE WORKING AREA IN FRONT OF EQUIPMENT.
5. PLATFORM SHALL NOT BE ATTACHED TO THE POLE
6. NO STRAIGHT (VERTICAL) LADDER/STAIRS

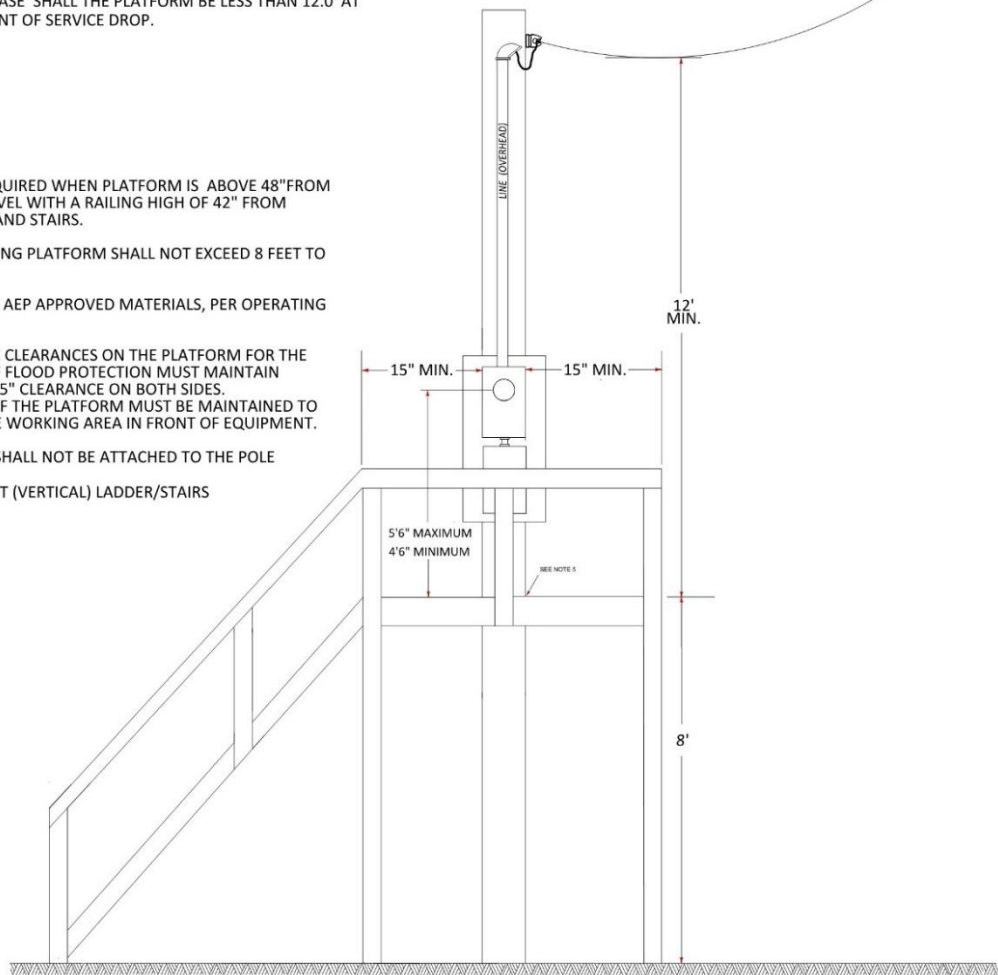

FOR FURTHER INFORMATION ON UTILITY REQUIREMENTS PLEASE CONTACT YOUR LOCAL AEP OPERATING COMPANY.

TYPICAL OVERHEAD METER EQUIPMENT  
SELF-STANDING PLATFORM INSTALLATION POLE MOUNT ABOVE FLOOD LEVEL

AMERICAN ELECTRIC POWER COMPANY  
DISTRIBUTION STANDARDS

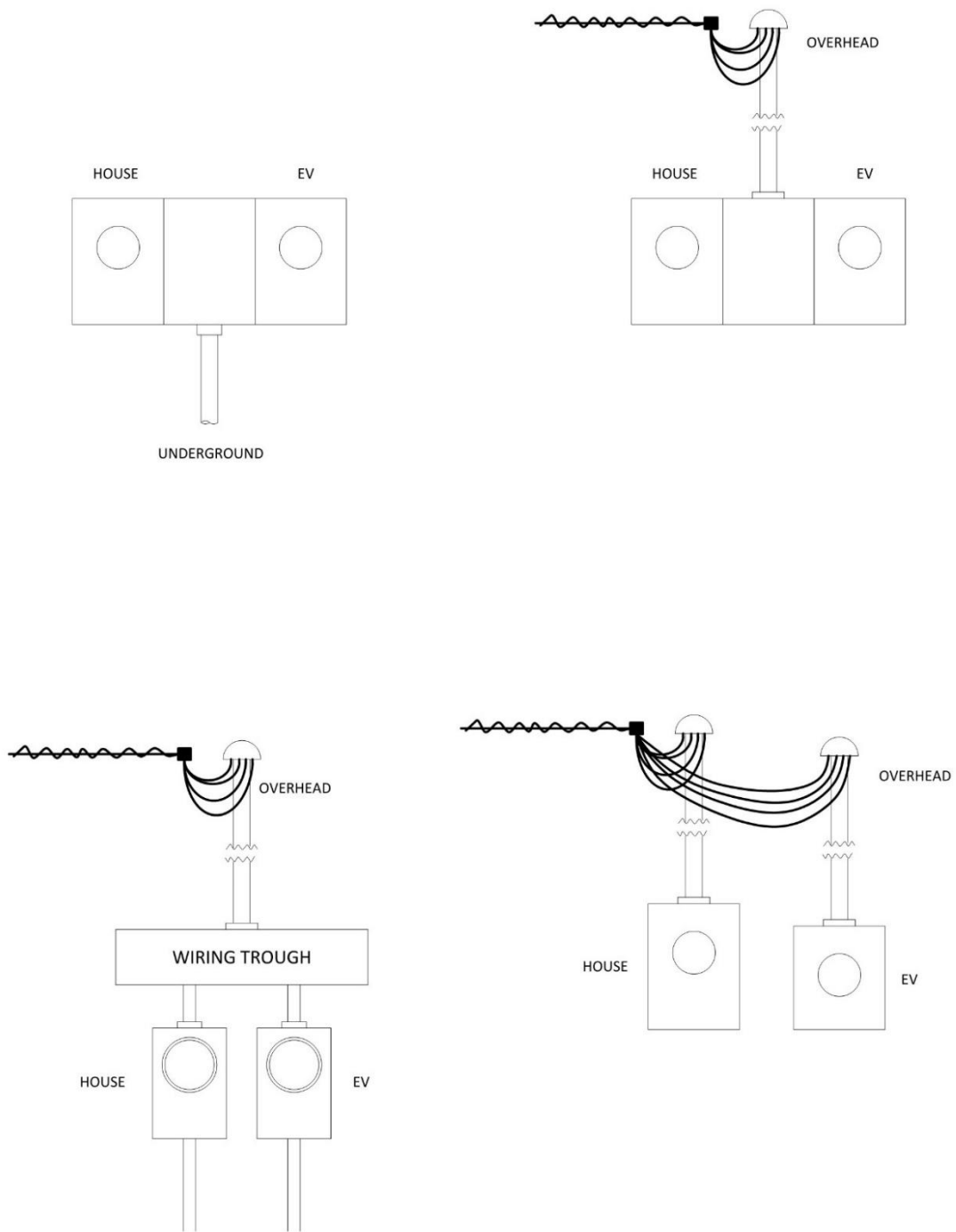

FOR FURTHER INFORMATION ON UTILITY REQUIREMENTS PLEASE CONTACT YOUR LOCAL AEP OPERATING COMPANY.

METER SOCKET LAYOUT  
FOR ADDING A SEPARATELY METERED ELECTRIC VEHICLE SERVICE

AMERICAN ELECTRIC POWER COMPANY  
DISTRIBUTION STANDARDS

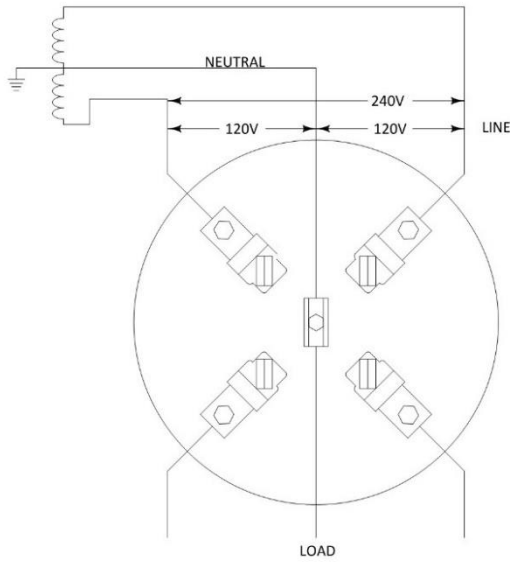

3-WIRE 120/240 VOLT  
SINGLE PHASE SELF CONTAINED

M.S.\_F023a

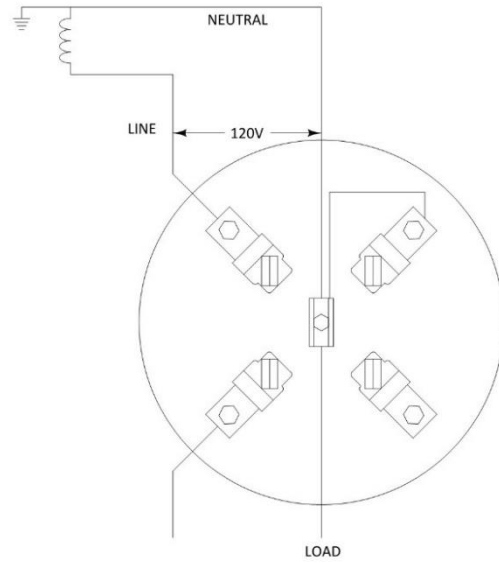

2-WIRE 120 VOLT  
SINGLE PHASE SELF CONTAINED

M.S.\_F023b

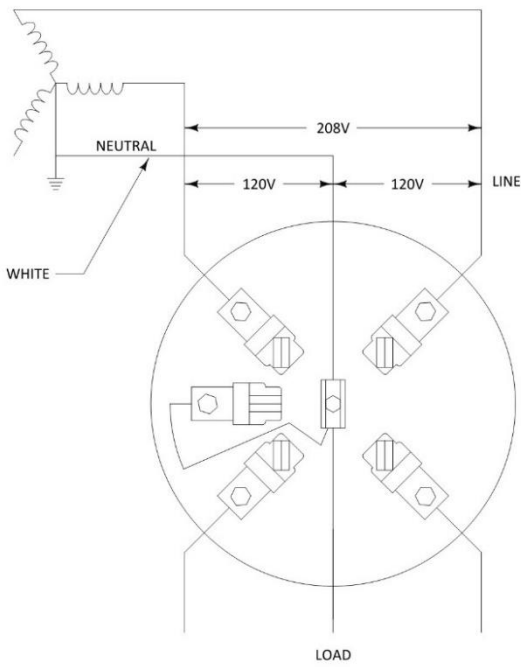

3-WIRE NETWORK 120/208 VOLT  
SINGLE PHASE SELF CONTAINED

M.S.\_F023c

INDIANA, KENTUCKY, MICHIGAN, OHIO, OKLAHOMA-RESIDENTIAL,  
TENNESSEE, TEXAS, VIRGINIA, WEST VIRGINIA

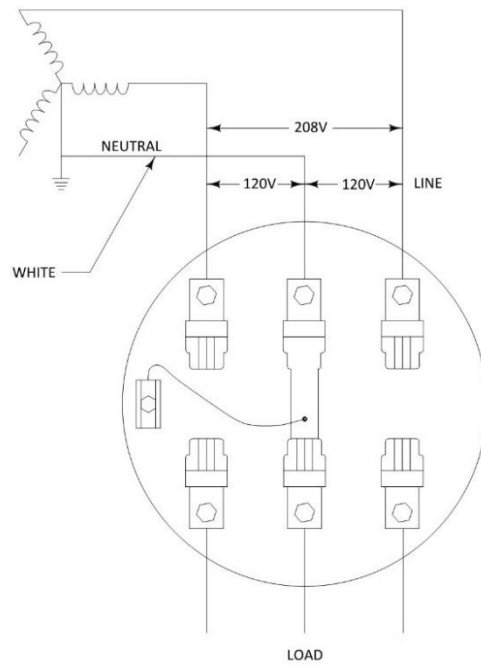

3-WIRE NETWORK 120/208 VOLT  
SINGLE PHASE SELF CONTAINED

M.S.\_F023d

SELF CONTAINED METER SOCKET CONNECTIONS (SINGLE PHASE AND NETWORK)

M.S.\_F024 – SELF-CONTAINED METER SOCKET CONNECTIONS (THREE WIRE AND FOUR WIRE DELTA)

AMERICAN ELECTRIC POWER COMPANY  
DISTRIBUTION STANDARDS

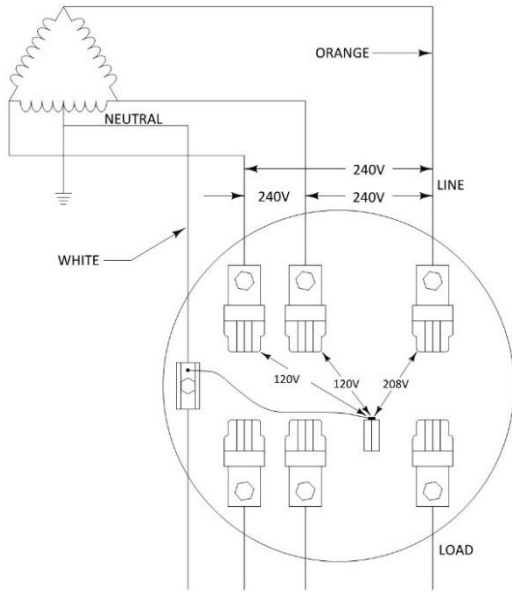

**4-WIRE DELTA 120/240 VOLT  
THREE PHASE SELF-CONTAINED**

ON A 4-WIRE DELTA CONNECTION, THE PHASE HAVING THE HIGHEST VOLTAGE TO GROUND ("HIGH" LEG OR "WILD" LEG) MUST BE CONNECTED TO THE RIGHT HAND TERMINALS OF THE METER SOCKET. IN OTHER LOCATION, SUCH AS SERVICE ENCLOSURES, DISCONNECTS, ETC., THE "HIGH" LEG IS CONNECTED TO THE CENTER TERMINAL.  
FIGURE M.S.\_F024a

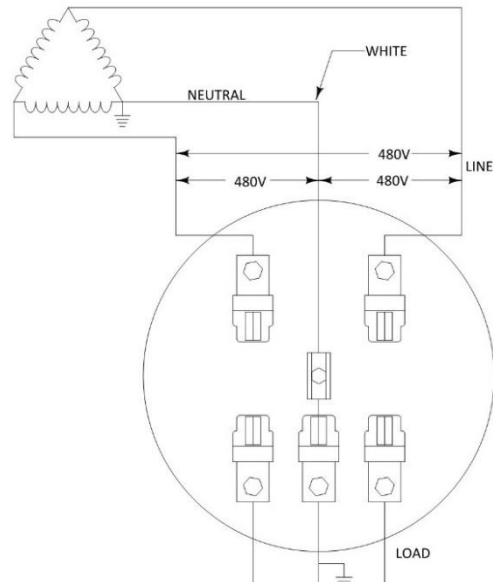

**3-WIRE 480 VOLT  
THREE PHASE SELF-CONTAINED  
CENTER PHASE DISCONNECT**  
OKLAHOMA, AEP TEXAS

FIGURE M.S.\_F024b

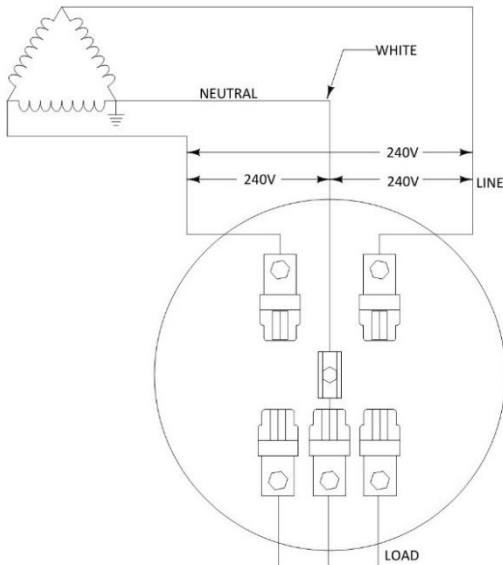

**3-WIRE 240 VOLT  
THREE PHASE SELF-CONTAINED  
CENTER PHASE DISCONNECT**  
ARKANSAS, OKLAHOMA, LOUISIANA, TEXAS

FIGURE M.S.\_F024c

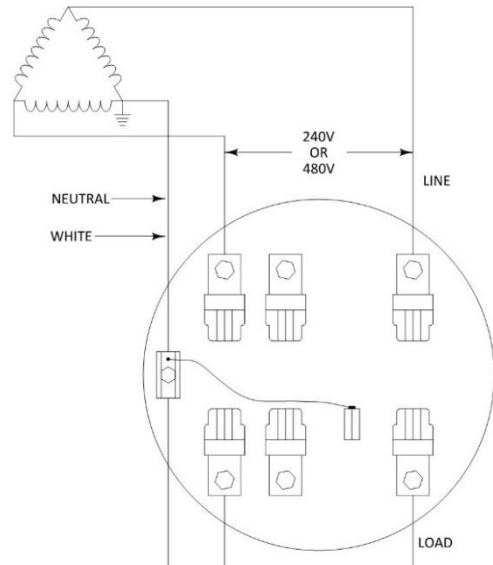

**3-WIRE 240 OR 480 VOLT  
THREE PHASE SELF-CONTAINED  
7 TERMINAL SOCKET**  
INDIANA, KENTUCKY, MICHIGAN, OHIO,  
TENNESSEE, VIRGINIA, WEST VIRGINIA

FIGURE M.S.\_F024d

SELF CONTAINED METER SOCKET CONNECTIONS (THREE WIRE AND FOUR WIRE DELTA)

AMERICAN ELECTRIC POWER COMPANY  
DISTRIBUTION STANDARDS

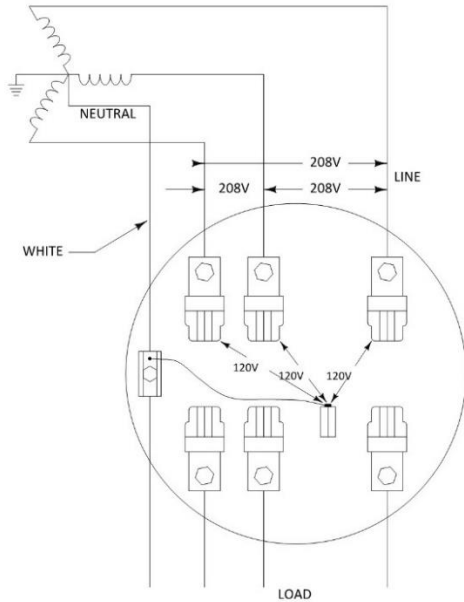

**4 WIRE WYE 120/208 VOLT  
THREE PHASE SELF CONTAINED**

FIGURE M.S.\_F025a

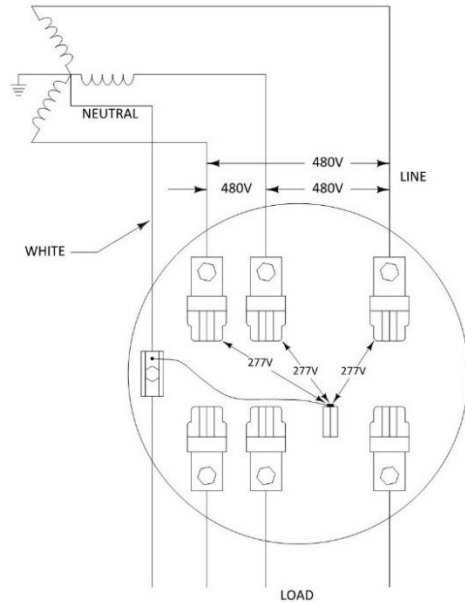

**4 WIRE WYE 277/480 VOLT  
THREE PHASE SELF CONTAINED**

FIGURE M.S.\_F025b

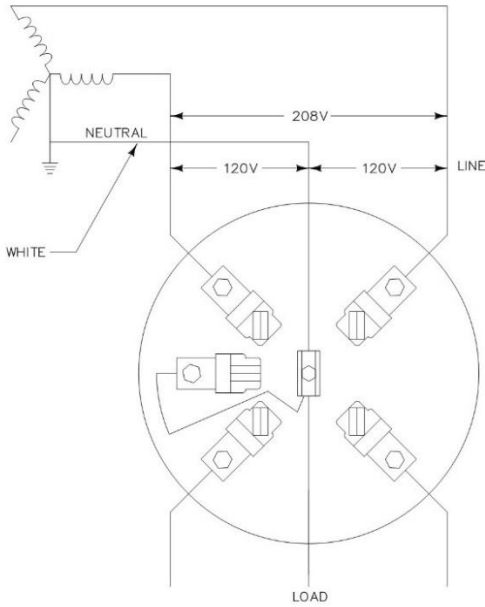

**3 WIRE NETWORK 120/208 VOLT  
SINGLE PHASE SELF CONTAINED**

INDIANA, KENTUCKY, MICHIGAN, OHIO, OKLAHOMA-RESIDENTIAL,  
TENNESSEE, TEXAS, VIRGINIA, WEST VIRGINIA  
FIGURE M.S.\_F025c

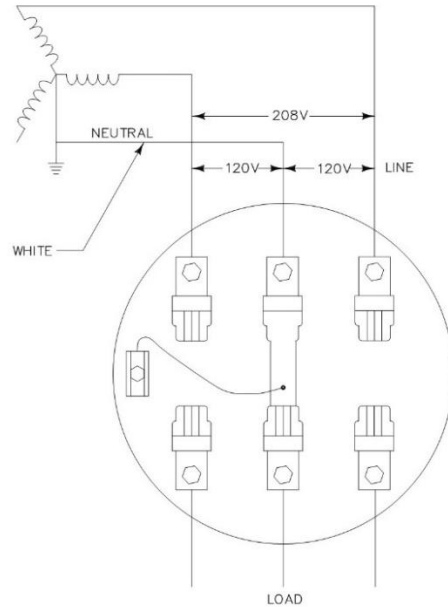

**3 WIRE NETWORK 120/208 VOLT  
SINGLE PHASE SELF CONTAINED**

FIGURE M.S.\_F025d

SELF CONTAINED METER SOCKET CONNECTIONS (THREE & FOUR WIRE WYE)

AMERICAN ELECTRIC POWER COMPANY  
METER STANDARDS

TABLE: I  
POLE DIMENSIONS AND SETTING DEPTH

LENGTH OF POLE (FEET)	MINIMUM SETTING DEPTH (FEET)	MINIMUM POLE DIMENSIONS (INCHES)	
		AT TOP 15"	AT TOP 4 3/4"
		AT GROUND LINE	AT GROUND LINE
18'	4'-0"	17 1/2"	5 1/2"
20'	4'-6"	18 1/2"	6"
22'	4'-6"	19 1/2"	6 1/4"
25'	5'-0"	20"	6 1/2"

GENERAL CONDITION NOTES:

THE COMPANY WILL BE RESPONSIBLE FOR:

- (a) SPECIFYING THE SERVICE POLE LOCATION, AND SERVICE DROP ATTACHMENT HEIGHT. NOTE: (NEC) RECOMMENDS THAT THE SERVICE EQUIPMENT BE "IN SIGHT FROM" AND WITHIN 30' OF THE FREE-STANDING STRUCTURE.
- (b) PROVIDING AND INSTALLING THE OVERHEAD SERVICE DROP.
- (c) PROVIDING THE METER BASE TO CUSTOMER WHERE REQUIRED.
- (d) INSTALLING AND REMOVING THE METER.

THE CUSTOMER WILL BE RESPONSIBLE FOR:

- (a) PROVIDING AN ADEQUATE GROUND TO THE FRAME OF THE SERVICE EQUIPMENT DISCONNECT DEVICE. GROUND IN ACCORDANCE WITH NEC ARTICLE 250 AND LOCAL CODES. GROUNDING IS TYPICALLY PROVIDED BY 8'-0" DRIVEN GROUND ROD(S) OR BY A METALLIC WATER PIPE BONDED TO 8'-0" DRIVEN GROUND ROD(S). IF A METALLIC WATER PIPING SYSTEM IS PRESENT, IT MUST BE BONDED TO THE 8'-0" DRIVEN GROUND ROD(S).
- (b) PROVIDING AND SECURELY INSTALLING THE SERVICE ENTRANCE CABLE, RIGID CONDUIT AND WEATHER HEAD AS REQUIRED BY LOCAL CODES. NON-METALLIC CONDUIT PERMITTED IF INSTALLED IN ACCORDANCE WITH NEC AND APPROVED BY LOCAL INSPECTION AUTHORITY. SERVICE ENTRANCE CONDUCTORS SHALL PROJECT FROM WEATHERHEAD A MINIMUM OF 18 INCHES. ONLY POWER SERVICE CONDUCTORS ARE ALLOWED TO CONTACT THE SERVICE MAST, NEC (230-28).
- (c) PROVIDING AND INSTALLING SERVICE EQUIPMENT DISCONNECT DEVICE. TYPICAL CONFIGURATIONS SHOWN (OTHER CONFIGURATIONS AVAILABLE). THE DISCONNECT DEVICE IS TO HAVE OVERCURRENT PROTECTION AND TO BE IN A WEATHERPROOF ENCLOSURE. CUSTOMER TO SELECT U.L LISTED EQUIPMENT BEST SUITED TO THEIR NEEDS.
- (d) SECURELY MOUNT THE METER BASE IN A PLUMB POSITION. METER MUST FACE STREET OR ACCESS WALKWAY.
- (e) PROVIDING AND SECURELY INSTALLING THE SERVICE POLE AND GUYING (IF NEEDED). SERVICE POLE IS TO BE TREATED WITH AN EPA REGISTERED PRESERVATIVE. POLE SETTING DEPTH TO BE IN ACCORDANCE WITH TABLE I.

GENERAL CONSTRUCTION NOTES:

1. THIS INSTALLATION IS FOR A SINGLE FREE-STANDING STRUCTURE ONLY. FOR FREE-STANDING STRUCTURES IN PARKS, REFER TO FIGURE 27.
2. THE SERVICE ATTACHMENT SHALL BE INSTALLED AT A HEIGHT THAT MAINTAINS PROPER CLEARANCES FOR SERVICE DROP CONDUCTORS. REFER TO FIGURE 5.
3. A GROUNDING AS WELL AS A GROUNDED CONDUCTOR MUST EXTEND BETWEEN THE FREE-STANDING STRUCTURE AND ITS ADJACENT SERVICE EQUIPMENT. NEITHER THE FRAME OF THE STRUCTURE, NOR THE FRAME OF ANY DISTRIBUTION PANEL OR APPLIANCE, MAY BE CONNECTED TO THE NEUTRAL (GROUNDED) CONDUCTOR IN THE FREE-STANDING STRUCTURE. THE GROUNDING AND GROUNDED CONDUCTOR ARE BONDED TOGETHER ONLY ON THE SUPPLY SIDE OF THE SERVICE DISCONNECT DEVICE. REFER TO ARTICLE 550 OF NEC GROUNDING.
4. BURIAL DEPTH IS THE DISTANCE BETWEEN FINAL GRADE AND THE TOP OF THE BURIED CABLE OR CONDUIT. THE POWER COMPANY (AEP) SHALL SPECIFY THE REQUIRED BURIAL DEPTH PER OPERATING COMPANY AS PRESCRIBED IN THE PRECEDING LIST:

COMPANY	BURIAL DEPTH
APCO	= REQUIRES A BURIAL DEPTH OF 30"
KYPCO	= REQUIRES A BURIAL DEPTH OF 30"
I&M	= REQUIRES A BURIAL DEPTH OF 30"
OHIO	= REQUIRES A BURIAL DEPTH OF 30"
TEXAS	= REQUIRES A BURIAL DEPTH OF 36"
PSO	= REQUIRES A BURIAL DEPTH OF 36"
SWPCO	= REQUIRES A BURIAL DEPTH OF 36"

AND/OR CONFORM TO ANY OR ALL AUTHORITY HAVING JURISDICTION. THE POWER COMPANY (AEP) HAS PRESCRIBED THE BURIAL DEPTH SHALL NOT BE LESS THAN STATED DEPTH ON THE PRECEDING LIST UNLESS IMPOSSIBLE TO BE ACHIEVED OR IS SUPERSEDED BY LOCAL AUTHORITY HAVING JURISDICTION. IF THE DEPTH IS IMPOSSIBLE TO ACHIEVED AEP'S VERIFICATION WILL BE NEEDED. HOWEVER, BURIAL DEPTH NOT TO BE LESS THAN WHAT IS STATED IN THE NATIONAL ELECTRICAL CODE'S ARTICLES AND ARTICLE 300: 300.3(B) (1), 300.3 (C) (1) (2), TABLE 300.5, AND TABLE 300.50

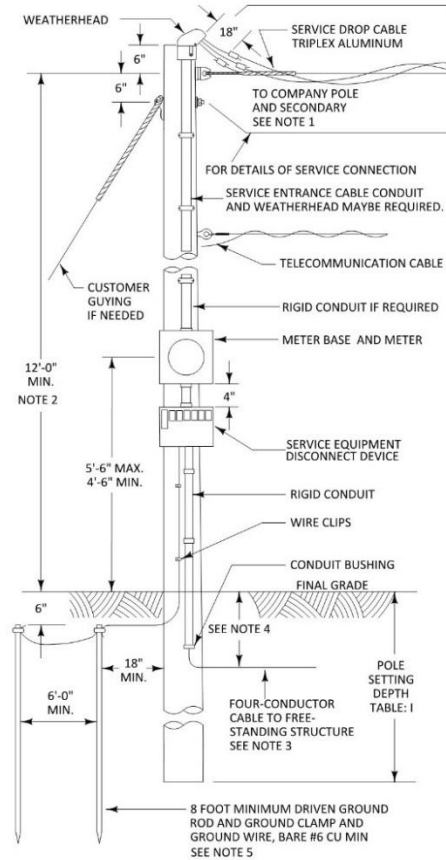

GENERAL CONSTRUCTION NOTE CONTINUED:

5. CUSTOMER GROUNDING SHALL BE IN ACCORDANCE WITH NATIONAL ELECTRICAL CODE. IN ARKANSAS, OKLAHOMA, LOUISIANA, AND TEXAS, THE GROUNDING WIRE SHALL BE CONNECTED TO THE UTILITIES NEUTRAL AT THIS POINT IN THE METER SOCKET. THE CUSTOMER SHALL HAVE A MINIMUM OF 2 DRIVEN GROUND RODS AT LEAST 6 FEET APART OR MUST MEET NEC GROUNDING REQUIREMENTS.
  6. AEP REQUIRES THAT SURGE PROTECTION BE EMPLOYED AS PER THE NEC ARTICLE 230.67 (BASE ON THE 2020). SURGE PROTECTION IN ALL NEW SERVICE AND SERVICE UPDATES
  7. ANTI-OXIDANT COMPOUNDS **SHALL NOT BE USED ON METER SOCKET BLADES OR METER BASE JAWS.** ANTI-OXIDANT COMPOUNDS CAN BE USED ON ALUMINUM CONDUCTORS AND METER BASE TERMINAL PER THE AHJ OF YOUR AREA.
- FOR FURTHER INFORMATION ON UTILITY REQUIREMENTS PLEASE CONTACT YOUR LOCAL AEP OPERATING COMPANY.**

SEE GENERAL CONDITION NOTES FOR POWER COMPANY AND CUSTOMER RESPONSIBILITIES

SINGLE FREE-STANDING STRUCTURE OVERHEAD SERVICE

AMERICAN ELECTRIC POWER COMPANY  
METER STANDARDS

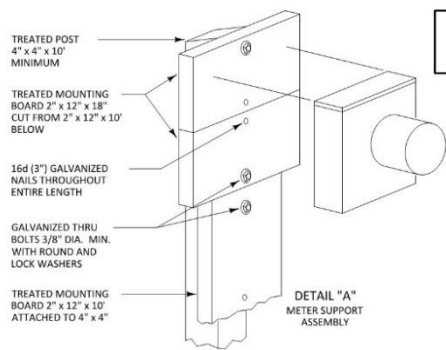

SEE GENERAL CONDITION NOTES FOR POWER COMPANY AND CUSTOMER RESPONSIBILITIES

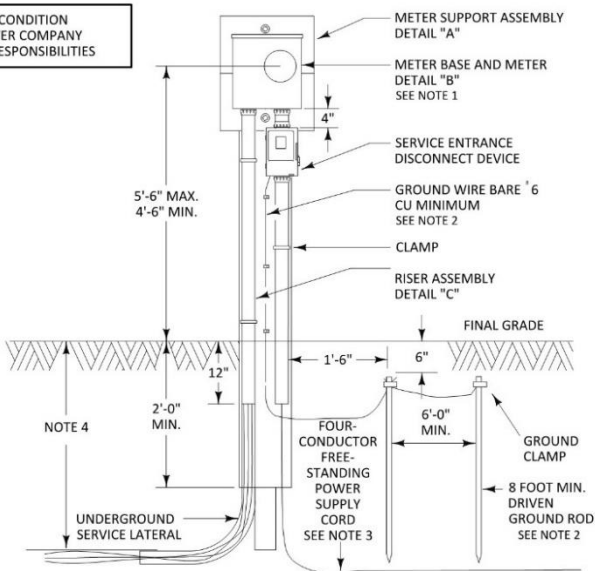

GENERAL CONDITION NOTES:

THE POWER COMPANY WILL BE RESPONSIBLE FOR:

- (a) SPECIFYING THE SERVICE POST LOCATION. NOTE: THE NATIONAL ELECTRICAL CODE (NEC) RECOMMENDS THAT THE SERVICE EQUIPMENT BE "IN SIGHT FROM" AND WITHIN 30 FEET OF THE MOBILE HOME. FOR RECREATIONAL VEHICLE SITE, REFER TO ARTICLE 551.77 OF THE NEC.
- (b) INSTALLING AND REMOVING THE METER.
- (c) PROVIDING AND INSTALLING THE UNDERGROUND SERVICE TERRITORIES WHERE REQUIRED.

THE CUSTOMER WILL BE RESPONSIBLE FOR:

- (a) PROVIDING GROUNDING IN ACCORDANCE WITH NATIONAL ELECTRICAL CODE AND LOCAL REGULATIONS. GROUND SHALL BE CONNECTED IN METER ENCLOSURE OR CUSTOMER SWITCH.
- (b) PROVIDING AND SECURELY INSTALLING THE METER POST AND EQUIPMENT MOUNTING BOARD WITH THE FOLLOWING REQUIREMENTS:
  1. TREATED WITH AN EPA REGISTERED PRESERVATIVE.
  2. METER POST WITH DIMENSIONS AS SHOWN, WITH THE TOP CUT AT ANGLE AWAY FROM MOUNTING BOARD FOR WATER DRAINAGE.
  3. EQUIPMENT MOUNTING BOARD WITH DIMENSIONS AS SHOWN, FOR MOUNTING THE METERING AND SERVICE EQUIPMENT DEVICES. MOUNTING BOARD TO BE NAILED (SIZE 20d) TO METER POST EVERY 16 INCHES WITH ADDITIONAL THRU BOLTS LOCATED AS SHOWN. SERVICE ENTRANCE CONDUCTORS OR CABLES NOT TO EXIT THROUGH REAR OF METER BASE.
  4. SECURELY MOUNTING THE METER BASE IN A LEVEL AND PLUMB POSITION. METER MUST FACE STREET OR ACCESS WALKWAY.
- (c) PROVIDING AND INSTALLING THE SERVICE EQUIPMENT DISCONNECT DEVICE. TYPICAL CONFIGURATION SHOWN (OTHER CONFIGURATIONS AVAILABLE). THE DISCONNECT DEVICE IS TO HAVE OVER CURRENT PROTECTION AND TO BE IN A WEATHERPROOF ENCLOSURE. CUSTOMER TO SELECT NEC APPROVED EQUIPMENT BEST SUITED TO THEIR NEEDS.
- (d) PROVIDING AND SECURELY INSTALLING THE SERVICE LATERAL CONDUIT, SERVICE ENTRANCE CONDUIT AND POWER-SUPPLY CORD IN ACCORDANCE WITH NEC AND LOCAL CODES. NON-METALLIC CONDUIT PERMITTED IF INSTALLED IN ACCORDANCE WITH ARTICLE 352 OF THE NEC AND ACCEPTABLE TO THE AUTHORITY HAVING JURISDICTION.

GENERAL CONSTRUCTION NOTES:

1. THIS INSTALLATION IS ALSO FOR FREE-STANDING STRUCTURES IN PARKS.
2. CUSTOMER IS TO SIZE GROUND WIRE ACCORDING TO NEC REQUIREMENTS. THE CUSTOMER SHALL HAVE A MINIMUM OF 2 DRIVEN GROUND RODS AT LEAST 6 FEET APART OR PER NEC.
3. A GROUNDING AS WELL AS A GROUNDED CONDUCTOR MUST EXTEND BETWEEN THE FREE-STANDING STRUCTURE AND ITS ADJACENT SERVICE EQUIPMENT. NEITHER THE FRAME OF THE STRUCTURE NOR THE FRAME OF ANY DISTRIBUTION PANEL OR APPLIANCE MAY BE CONNECTED TO THE NEUTRAL (GROUNDED) CONDUCTOR IN THE FREE-STANDING STRUCTURE. THE GROUNDING AND GROUNDED CONDUCTORS ARE BONDED TOGETHER ONLY ON THE SUPPLY SIDE OF THE SERVICE DISCONNECT DEVICE. REFER TO ARTICLE 550 OF THE NEC - GROUNDING.
4. ANTI-OXIDANT COMPOUNDS **SHALL NOT BE USED ON METER SOCKET BLADES OR METER BASE JAWS.** ANTI-OXIDANT COMPOUNDS CAN BE USED ON ALUMINUM CONDUCTORS AND METER BASE TERMINAL PER THE AHJ OF YOUR AREA.
5. AEP REQUIRES THAT SURGE PROTECTION BE EMPLOYED AS PER THE NEC ARTICLE 230.67 (BASE ON THE 2020). SURGE PROTECTION IN ALL NEW SERVICE AND SERVICE UPDATES

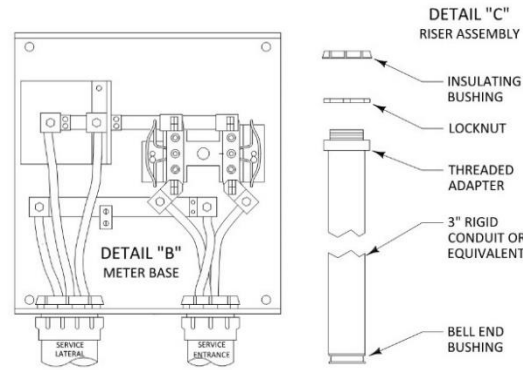

GENERAL CONSTRUCTION NOTES CONTINUED:

- 6. BURIAL DEPTH IS THE DISTANCE BETWEEN FINAL GRADE AND THE TOP OF THE BURIED CABLE OR CONDUIT. THE POWER COMPANY (AEP) SHALL SPECIFY THE REQUIRED BURIAL DEPTH PER OPERATING COMPANY AS PRESCRIBED IN THE PROCEEDING LIST:

COMPANY	BURIAL DEPTH
APCO	= REQUIRES A BURIAL DEPTH OF 30"
KYPCO	= REQUIRES A BURIAL DEPTH OF 30"
I&M	= REQUIRES A BURIAL DEPTH OF 30"
OHIO	= REQUIRES A BURIAL DEPTH OF 30"
TEXAS	= REQUIRES A BURIAL DEPTH OF 36"
PSO	= REQUIRES A BURIAL DEPTH OF 36"
SWPECO	= REQUIRES A BURIAL DEPTH OF 36"

AND/OR CONFORM TO ANY OR ALL AUTHORITY HAVING JURISDICTION. THE POWER COMPANY (AEP) HAS PRESCRIBED THE BURIAL DEPTH SHALL NOT BE LESS THAN STATED DEPTH ON THE PRECEDING LIST UNLESS IMPOSSIBLE TO BE ACHIEVED OR IS SUPERSEDED BY LOCAL AUTHORITY HAVING JURISDICTION. IF THE DEPTH IS IMPOSSIBLE TO ACHIEVED AEP'S VERIFICATION WILL BE NEEDED. HOWEVER, BURIAL DEPTH NOT TO BE LESS THAN WHAT IS STATED IN THE NATIONAL ELECTRICAL CODE'S ARTICLES AND ARTICLE 300.3(B) (1), 300.3 (C) (1) (2), TABLE 300.5, AND TABLE 300.50

PROVIDING GROUNDING IN ACCORDANCE WITH NATIONAL ELECTRICAL CODE AND LOCAL REGULATIONS. GROUND SHALL BE CONNECTED IN METER ENCLOSURE OR CUSTOMER SWITCH.

FOR FURTHER INFORMATION ON UTILITY REQUIREMENTS PLEASE CONTACT YOUR LOCAL AEP OPERATING COMPANY.

SINGLE FREE-STANDING STRUCTURE UNDERGROUND SERVICE

AMERICAN ELECTRIC POWER COMPANY  
METER STANDARDS

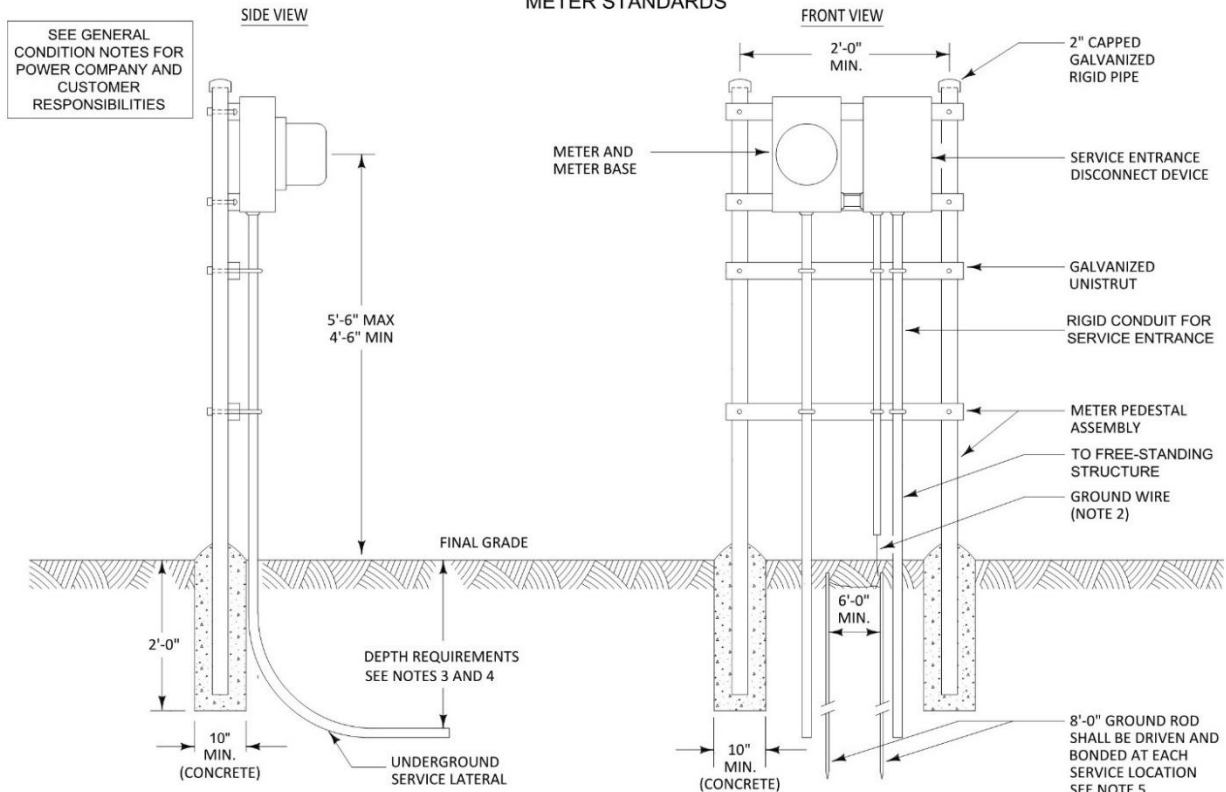

GENERAL CONDITION NOTES:

THE POWER COMPANY WILL BE RESPONSIBLE FOR:

- (a) SPECIFYING THE METER PEDESTAL LOCATION. NOTE: THE NATIONAL ELECTRICAL CODE (NEC) RECOMMENDS THAT THE SERVICE EQUIPMENT BE "IN SIGHT FROM" AND WITHIN 30'-0" OF THE MOBILE HOME.
- (b) INSTALLING AND REMOVING THE METER.
- (c) PROVIDING AND INSTALLING THE UNDERGROUND SERVICE LATERAL CONDUCTORS.

THE CUSTOMER WILL BE RESPONSIBLE FOR:

- (a) PROVIDING AND INSTALLING THE METER PEDESTAL.
- (b) PROVIDING AND INSTALLING THE METER BASE.
- (c) PROVIDING AN ADEQUATE GROUND TO THE SERVICE EQUIPMENT DISCONNECT DEVICE. GROUND IN ACCORDANCE WITH ARTICLE 250 OF THE NATIONAL ELECTRICAL CODE (NEC).
- (d) SECURELY INSTALLING THE METER PEDESTAL AS SHOWN.
- (e) SECURELY MOUNTING THE METER BASE IN A LEVEL AND PLUMB POSITION. METER MUST FACE STREET OR ACCESS WALKWAY.
- (f) PROVIDING AND INSTALLING THE SERVICE EQUIPMENT DISCONNECT DEVICE.
- (g) PROVIDING SERVICE ENTRANCE CONDUCTORS OF SUFFICIENT AMPACITY TO SERVE THE CONNECTED LOAD ACCORDING TO THE CURRENT NEC.

GENERAL CONSTRUCTION NOTES:

- 1. THIS INSTALLATION IS ALSO FOR FREE-STANDING STRUCTURES IN PARKS.
- 2. CUSTOMER IS TO SIZE GROUND WIRE ACCORDING TO NEC REQUIREMENTS.
- 3. ANTI-OXIDANT COMPOUNDS **SHALL NOT BE USED ON METER SOCKET BLADES OR METER BASE JAWS.**

ANTI-OXIDANT COMPOUNDS CAN BE USED ON ALUMINUM CONDUCTORS AND METER BASE TERMINAL PER THE AHJ OF YOUR AREA.

**FOR FURTHER INFORMATION ON UTILITY REQUIREMENTS PLEASE CONTACT YOUR LOCAL AEP OPERATING COMPANY.**

- 3. BURIAL DEPTH IS THE DISTANCE BETWEEN FINAL GRADE AND THE TOP OF THE BURIED CABLE OR CONDUIT. THE POWER COMPANY (AEP) SHALL SPECIFY THE REQUIRED BURIAL DEPTH PER OPERATING COMPANY AS PRESCRIBED IN THE PROCEEDING LIST:

COMPANY	BURIAL DEPTH
APCO	= REQUIRES A BURIAL DEPTH OF 30"
KYPCO	= REQUIRES A BURIAL DEPTH OF 30"
I&M	= REQUIRES A BURIAL DEPTH OF 30"
OHIO	= REQUIRES A BURIAL DEPTH OF 30"
TEXAS	= REQUIRES A BURIAL DEPTH OF 36"
PSO	= REQUIRES A BURIAL DEPTH OF 36"
SWEPCO	= REQUIRES A BURIAL DEPTH OF 36"

AND/OR CONFORM TO ANY OR ALL AUTHORITY HAVING JURISDICTION. THE POWER COMPANY (AEP) HAS PRESCRIBED THE BURIAL DEPTH SHALL NOT BE LESS THAN STATED DEPTH ON THE PRECEDING LIST UNLESS IMPOSSIBLE TO BE ACHIEVED OR IS SUPERSEDED BY LOCAL AUTHORITY HAVING JURISDICTION. IF THE DEPTH IS IMPOSSIBLE TO ACHIEVED AEP'S VERIFICATION WILL BE NEEDED. HOWEVER, BURIAL DEPTH NOT TO BE LESS THAN WHAT IS STATED IN THE NATIONAL ELECTRICAL CODE'S ARTICLES AND TABLES: ARTICLE 300.3(B) (1), 300.3 (C) (1) (2), TABLE 300.5, AND TABLE 300.50.

- 4. BURIAL DEPTH TO COMPLY WITH LOCAL CODES. 2'-0" MIN. IS CONSIDERED ADEQUATE BY ARTICLE 300-5 OF THE NEC. A GROUNDING AS WELL AS A GROUNDED CONDUCTOR MUST EXTEND BETWEEN THE FREE-STANDING STRUCTURE AND ITS ADJACENT SERVICE EQUIPMENT. NEITHER THE FRAME OF THE STRUCTURE NOR THE FRAME OF ANY DISTRIBUTION PANEL OR APPLIANCE MAY BE CONNECTED TO THE NEUTRAL (GROUNDED) CONDUCTOR IN THE FREE-STANDING STRUCTURE. THE GROUNDING AND GROUNDED CONDUCTORS ARE BONDED TOGETHER ONLY ON THE SUPPLY SIDE OF THE SERVICE DISCONNECT DEVICE. REFER TO ARTICLE 550 OF THE NEC - GROUNDING.
- 5. CUSTOMER GROUNDING SHALL BE IN ACCORDANCE WITH NEC AND LOCAL REGULATIONS. IN ARKANSAS, OKLAHOMA, LOUISIANA, AND TEXAS, THE GROUND WIRE SHALL BE CONNECTED IN THE METER SOCKET IN CONDUIT WHERE REQUIRED. THE CUSTOMER SHALL HAVE A MINIMUM OF 2 DRIVEN GROUND RODS AT LEAST 6 FEET APART.
- 6. AEP REQUIRES THAT SURGE PROTECTION BE EMPLOYED AS PER THE NEC ARTICLE 230.67 (BASE ON THE 2020). SURGE PROTECTION IN ALL NEW SERVICE AND SERVICE UPDATES
- 7. PLEASE CHECK WITH YOUR LOCAL AHJ (AUTHORITY HAVING JURISDICTION) TO VERIFY WHETHER YOU ARE REQUIRED TO INSTALL A FULL SERVICE SURGE PROTECTION PER NEC 2020.

SINGLE FREE-STANDING STRUCTURE UNDERGROUND SERVICE  
(ALTERNATE METER PEDESTAL)

**M.S.\_F028 – CURRENT TRANSFORMER CABINET, FREE STANDING, OVERHEAD, WINDOW-TYPE CTS (WITH VT ISOLATION CABINET/METER SOCKET COMBINATION)**

AMERICAN ELECTRIC POWER COMPANY  
METER STANDARDS

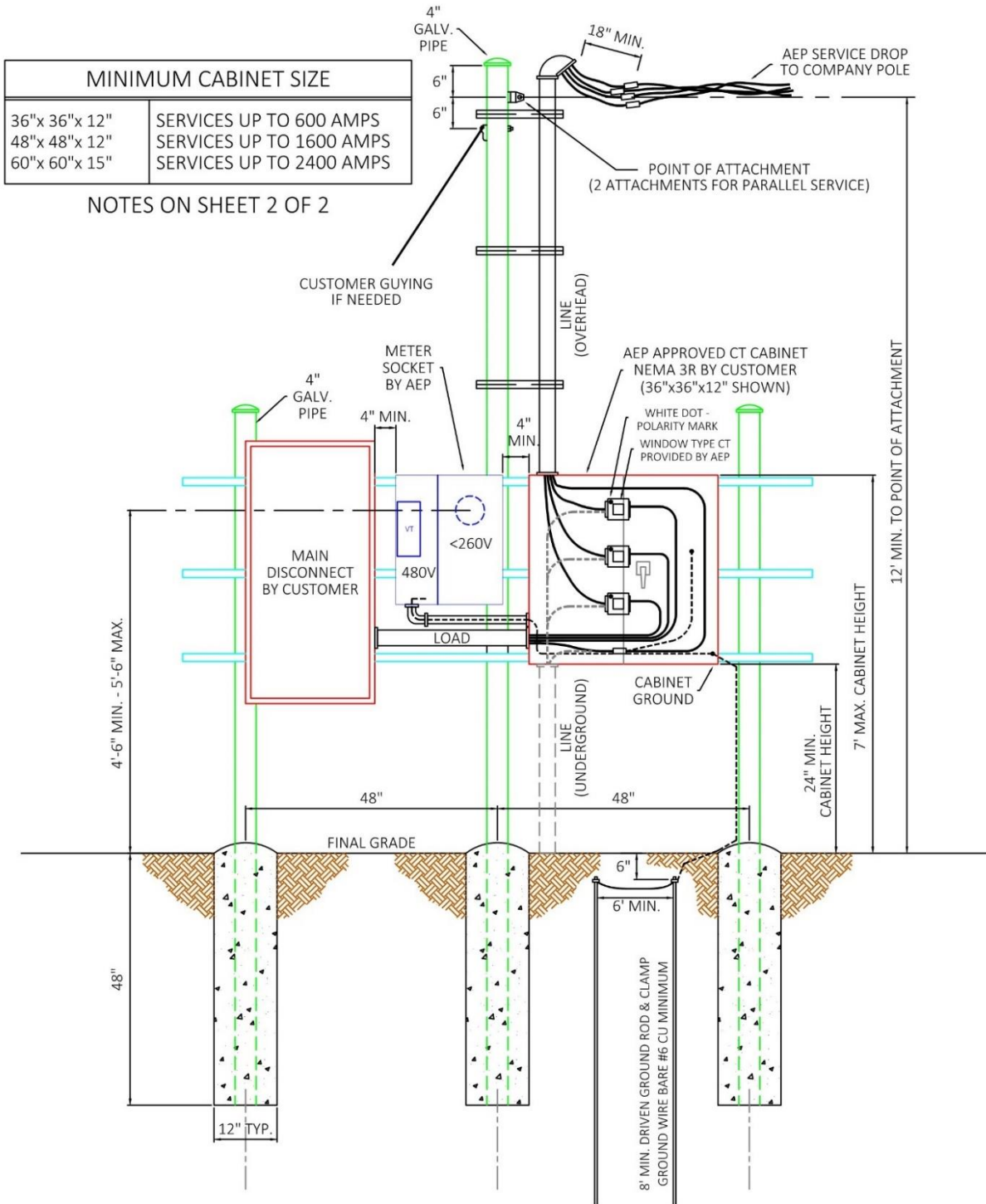

MINIMUM CABINET SIZE	
36"x 36"x 12"	SERVICES UP TO 600 AMPS
48"x 48"x 12"	SERVICES UP TO 1600 AMPS
60"x 60"x 15"	SERVICES UP TO 2400 AMPS

NOTES ON SHEET 2 OF 2

**FOR FURTHER INFORMATION ON UTILITY REQUIREMENTS PLEASE CONTACT YOUR LOCAL AEP OPERATING COMPANY.**

CURRENT TRANSFORMER CABINET, FREE STANDING, OVERHEAD, WINDOW TYPE CT'S  
(WITH VT ISOLATION CABINET/METER SOCKET COMBINATION)

MARCH 24, 2025

FIGURE M.S.\_F028

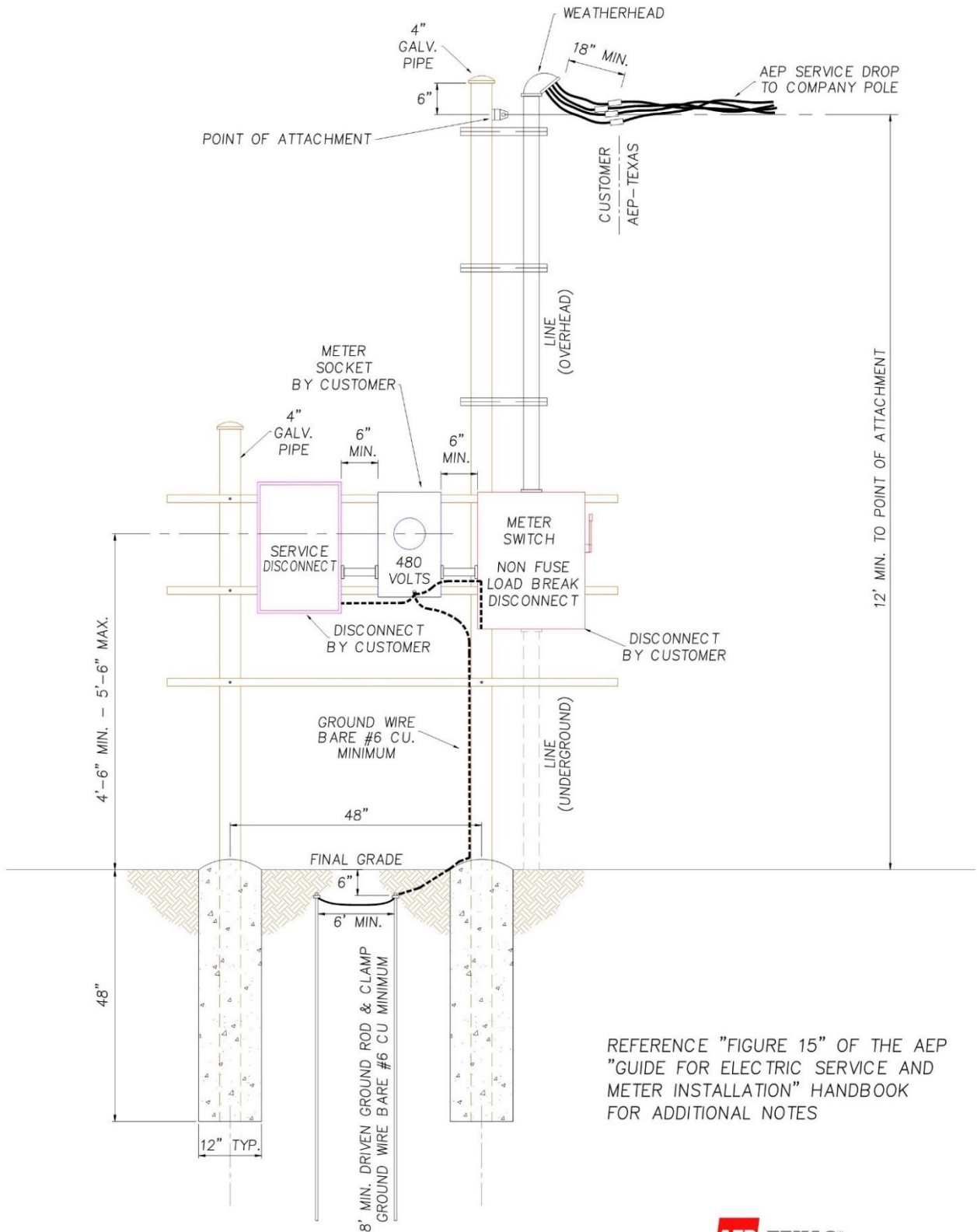

DWG. NAME: 480V DELTA OR 277/480V WYE, 200A & BELOW SELF CONTAINED METER w/ METER DISCONNECT		REGION: CC DISTRICT	
SCALE: 1/2"=1'-0"	REV. DATE: 12/6/2019	ENG. APP.:	FILE NAME: STRUC-65
		G.T.	DRAWN BY:

STRUC-65.2 – CURRENT TRANSFORMER CABINET, FREE STANDING, OVERHEAD, WINDOW-TYPE CTS

MINIMUM CABINET SIZE	
36" x 36" x 12"	SERVICES UP TO 600 AMPS
48" x 48" x 12"	SERVICES UP TO 1600 AMPS
60" x 60" x 15"	SERVICES UP TO 2400 AMPS

NOTES ON SHEET 2 OF 2

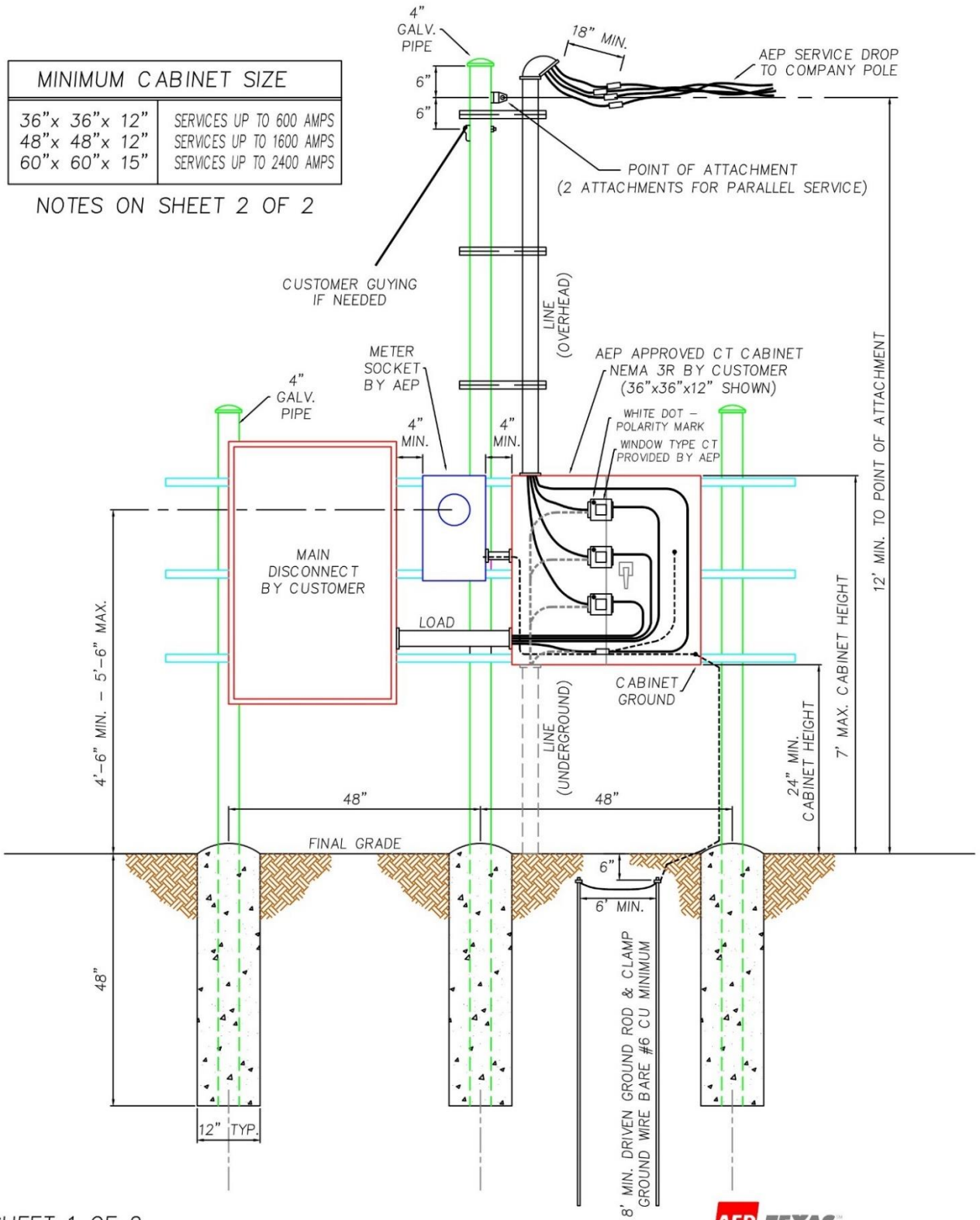

SHEET 1 OF 2



DWG. NAME: CURRENT TRANSFORMER CABINET, FREE STANDING, OVERHEAD, WINDOW TYPE CTS		REGION: CC DISTRICT	
SCALE: 1/2"=1'-0"	REV. DATE: 8/4/2021	ENG. APP.:	FILE NAME: STRUC-65
		G.T.	DRAWN BY:

## NOTES

- 1) CT CABINET, FURNISHED AND INSTALLED BY CUSTOMER, SHALL BE OF SUBSTANTIAL STRENGTH WITH CORROSION PROTECTION, SUCH AS PAINTED GALVANIZED STEEL NEMA 3R. ALUMINUM OR FIBER REINFORCED POLYESTER ENCLOSURES MUST BE USED IN CORROSIVE AREAS. IT SHALL BE FITTED WITH HINGED DOORS AND SHALL HAVE PROVISIONS FOR INSTALLING A COMPANY PADLOCK AND SEAL. THE INSIDE BACK OF THE CABINET SHALL BE ENTIRELY COVERED BY 3/4" TREATED PLYWOOD FOR MOUNTING THE CURRENT TRANSFORMERS OR (AEP TEXAS) SUITABLE MOUNTING BRACKETS MAY BE PROVIDED. A GROUNDING LUG SHALL BE PROVIDED TO GROUND THE CABINET.
  
- 2) THE WHITE DOT POLARITY MARK ON THE CT SHALL BE TOWARD THE ENERGY SOURCE OR LINE SIDE.
  
- 3) CUSTOMER SHOULD MOUNT THE METER SOCKET OR CABINET NEXT TO THE CT CABINET AND INSTALL 1 1/4" CONDUIT BETWEEN THE TWO. IF THE METER SOCKET CANNOT BE INSTALLED NEXT TO THE CT CABINET, IT MAY BE LOCATED UP TO 20 FEET AWAY WITH COMPANY METER SERVICES APPROVAL. 1 1/4" CONDUIT SHALL CONNECT THE SOCKET AND CT CABINET.
  
- 4) THE CT CABINET AND METER SOCKET SHALL BE GROUNDED. THE METER SOCKET AND CT CABINET SHALL BE BONDED THROUGH A SEPARATE EQUIPMENT-GROUNDING CONDUCTOR CONNECTED TO THE GROUNDED SERVICE CONDUCTOR (USUALLY THE NEUTRAL). IF A GROUNDED SERVICE CONDUCTOR DOES NOT EXIST THEN GROUNDING AND BONDING OF METERING EQUIPMENT MUST BE ESTABLISHED THROUGH A GROUNDING ELECTRODE SYSTEM ESTABLISHED AT THE POINT OF SERVICE. IN SOME JURISDICTIONS THE GROUNDING OF THE METER SOCKET AND INSTRUMENT TRANSFORMER ENCLOSURE WILL BE SUPPLEMENTED WITH THE USE OF A DRIVEN GROUND ROD IN ADDITION TO BONDING TO THE GROUNDED SERVICE CONDUCTOR. REFER TO SECTION 9 FOR CT CABINET SPECIFICATIONS.
  
- 5) COMPANY WILL INSTALL THE SECONDARY WIRING BETWEEN THE CT AND THE METER SOCKET.
  
- 6) FOR UNDERGROUND APPLICATIONS – BURIAL DEPTH IS THE DISTANCE BETWEEN FINAL GRADE AND THE TOP OF THE BUIED CABLE OR CONDUIT. THE POWER COMPANY SHALL SPECIFY THE REQUIRED BURIAL DEPTH TO CONFIRM TO LOCAL REQUIREMENTS. THE BURIAL DEPTH SHALL NOT BE LESS THAN 3'-0".
  
- 7) FOR UNDERGROUND APPLICATIONS – THE COMPANY WILL BE RESPONSIBLE FOR: DESIGNATING THE LOCATOIN FOR THE TRENCH AND THE METER, PROVIDING AND INSTALLING THE UNDERGROUND SERVICE LATERAL IN SERVICE TERRITORIES WHERE REQUIRED, PROVIDING THE METER BASE TO CUSTOMER WHERE REQUIRED.

SHEET 2 OF 2



<small>DWG. NAME</small>	CURRENT TRANSFORMER CABINET, FREE STANDING, OVERHEAD, WINDOW TYPE CTS	<small>REGION:</small>	CC DISTRICT T
<small>SCALE:</small>	<small>REV. DATE:</small>	<small>ENG. APP.</small>	<small>FILE NAME</small>
1/2"=1'-0"	11/8/2016	G.T.	STRUC-65
		<small>DRAWN BY:</small>	

# Appendix

---

-- This section is empty and reserved for future use. --

	Guide for Electric Service and Meter Installations	Rev. 1.01	
	CAUTION: Printed copies of this document are uncontrolled and may be obsolete. Always check for the latest revision prior to use.		Page 80